

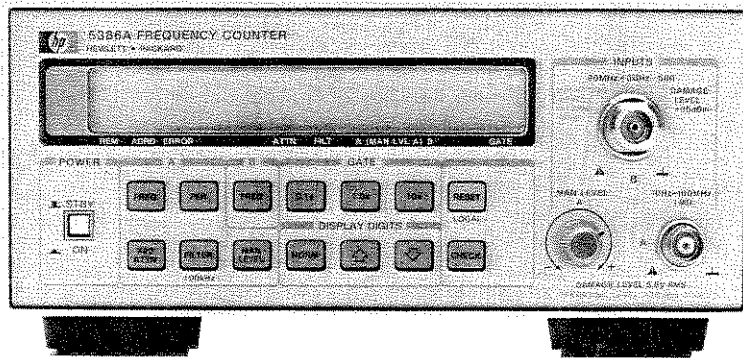

# 5386A

## Frequency Counter





HEWLETT  
PACKARD

OPERATING AND SERVICE MANUAL

# HP 5386A

## Frequency Counter

**SERIAL PREFIX: 2534A**

This manual applies to Serial prefix 2534A, unless accompanied by a Manual change Sheet indicating otherwise.

©Copyright HEWLETT-PACKARD COMPANY 1985  
5301 STEVENS CREEK BOULEVARD, SANTA CLARA, CA 95051

MANUAL PART NUMBER 05386-90001  
Microfiche Part Number 05386-90002

Printed: FEB 1986

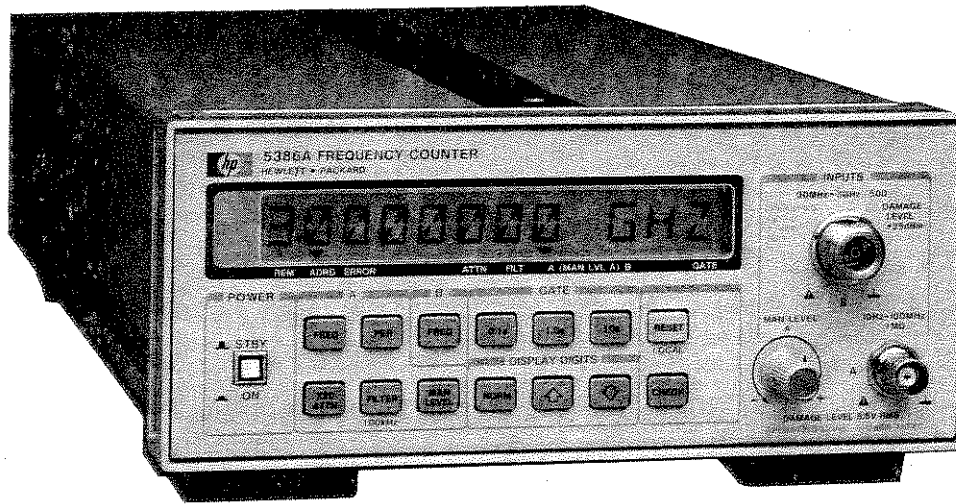

Model HP 5386A

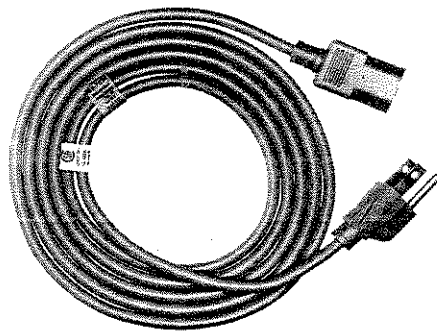

POWER CORD  
PART NO. 8120-1378

Figure 1-1. Model HP 5386A Frequency Counter and Accessories

## SECTION I GENERAL INFORMATION

### 1-1. INTRODUCTION

1-2. This manual provides you with information pertaining to the installation, operating, programming, performance tests, adjustments, and maintenance of the Hewlett-Packard Model 5386A Frequency Counter, shown in *Figure 1-1*.

### 1-3. MANUAL SUMMARY

1-4. The manual is divided into eight sections, each covering a particular topic for the operation of the HP 5386A Frequency Counter. The topics by section number are:

Section	Topic
I	General Information
II	Installation
III	Operation and Programming
IV	Performance Tests
V	Adjustments
VI	Replaceable Parts
VII	Manual Changes
VIII	Service

### 1-5. SPECIFICATIONS

1-6. The instrument specifications and option specifications are listed in *Table 1-1*. These specifications are performance standards or limits against which the instrument may be tested.

### 1-7. SAFETY CONSIDERATIONS

1-8. This is a Safety Class I instrument. This instrument has been designed and tested according to international safety requirements.

1-9. This manual contains information, cautions, and warnings which must be followed by operating and service personnel to ensure safe operation and to retain the instrument in safe condition.

### 1-10. DESCRIPTION

1-11. The Hewlett-Packard Model 5386A is a frequency counter that makes frequency and period measurements. The HP 5386A has a frequency range of 10 Hz to 3 GHz. The counter is a microcomputer based instrument with a data bus port for remote operation through HP-IB.

1-12. Channel "A" has a female BNC type connector. Channel "B" has a female N type connector.

1-13. To the left of the "A" channel input connector is a control that allows you to set the trigger level of Channel A.

1-14. A 100 kHz low pass filter can be toggled in or out of the Channel A signal path.

1-15. Measurement display and mode annunciators are shown on a 12-character alphanumeric liquid crystal display (LCD). Frequency and period measurements are displayed in engineering format, with three alpha characters used to designate units, e.g., MHz. The display will also give you brief messages and diagnostic prompts.

1-16. The HP 5386A is designed so it may either be rack mounted or stacked.

1-17. A 10 MHz reference oscillator output is included. The connector for the 10 MHz output may also be used as an external 10 MHz reference oscillator input connection.

1-18. Option 004 is an ovenized oscillator that provides a high stability time base giving substantially higher accuracy over variations in time and temperature.

1-19. HP-IB is the Hewlett-Packard Interface Bus for remote control of the counters by computers and controllers. It is a standard feature in the instrument.

1-20. The HP-IB, (Hewlett-Packard Interface Bus) is Hewlett-Packard's implementation of IEEE Standard 488-1978 and ANSI Standard MC 1.1. HP-IB is a high-speed parallel interface bus. All devices on the bus are capable of being addressed at one time. However, only one device may respond at a time. A controller is used to command which device responds. (The HP 5386A would make measurements and return data upon commands from a controller.)

1-21. HP-IB allows the HP 5386A to output data to other devices or, on a more complex level, respond to remote programming instructions to make a specific type of measurement, trigger that measurement, then read the result and send the reading back to the controller, or to another device on the interface.

## 1-22. OPTION 004

1-23. Option 004 is an ovenized oscillator that gives the HP 5386A increased accuracy by providing a more stable time base reference signal. The oven maintains the crystal at a constant elevated temperature for increased stability over the ambient temperature range.

## 1-24. INSTRUMENT IDENTIFICATION

1-25. Hewlett-Packard instruments have a 2-section, 10-character serial number (0000A00000), which is located on the rear panel. The four-digit serial prefix identifies the instrument changes. If the serial prefix of your instrument differs from that listed on the title page of this manual, there are differences between this manual and your instrument. Instruments having higher serial prefixes are covered with a "Manual Changes" sheet included with this manual. If the change sheet is missing, contact the nearest Hewlett-Packard Sales and Support Office listed at the back of this manual. Instruments having a lower serial prefix than that listed on the title page are covered in Section VII.

## 1-25. ACCESSORIES

1-26. The accessory supplied is a detachable power cord 229 cm long (7½ feet), part number 8120-1378.

1-27. Side Handle Kit: 5061-0088

1-28. Rack Mount Kits:

Single: HP Part Number 5061-0072

Dual: HP Part Number 5061-0074

and HP Part Number 5061-0094

## 1-29. RECOMMENDED TEST EQUIPMENT

1-30. The test equipment listed in *Table 1-2* is recommended for use during performance tests, adjustments, and troubleshooting. Substitute test equipment may be used if it meets the required characteristics listed in the table.

Table 1-1. Model HP 5386A Specifications

## HP 5386A INPUT CHARACTERISTICS

### CHANNEL A

**Range:** 10 Hz to 100 MHz

**Sensitivity:** [MAN LEVEL] off

15 mVrms sine wave 10 Hz to 100 MHz

45 mV pk-pk 5 ns minimum pulse width

**Dynamic Range:** 45 mV to 4 V pk-pk × attenuator setting.

**Coupling:** AC

**Impedance:**

X1: 1 MΩ NOMINAL || <25 pF

X20: 500 kΩ NOMINAL || <25 pF

**Attenuator:** X1 or X20 NOMINAL, X20 increases to X40 below 50 Hz.

**Low Pass Filter:** 100 kHz NOMINAL 3 dB point

**Trigger Level:**

[MAN LEVEL] ON: variable from -0.1 V to +0.1 V × attenuator setting about average signal value.

[MAN LEVEL] OFF: automatically set to average value of signal.

**Damage Level:**

X1:

10 - 200 Hz 350 V (DC + AC peak)

0.2 - 420 kHz 170 V (DC + AC peak)

0.42 - 10 MHz (5 × 10<sup>7</sup> Vrms Hz)/FREQ

>10 MHz 5 Vrms

X20:

<1 MHz, same as X1

>1 MHz, 50 Vrms

### CHANNEL B

**Range:** 90 MHz to 3 GHz, prescaled.

**Sensitivity:** 10 mVrms (-27 dBm)

**Dynamic Range:** 10 mV to .5 Vrms (-27 dBm to +7 dBm)

**Coupling:** AC

**Impedance:** 50 Ω NOMINAL

VSWR <2.5:1 TYPICAL

Note: Manual level not active for Channel B.

**Damage Level:**

AC > 4V (+25 dBm)

DC ± 5V

### FREQUENCY A and B

**Range Channel A:** 10 Hz - 100 MHz

**Range Channel B:** 90 MHz - 3 GHz, prescaled.

**LSD Displayed:** 10 Hz to 1 nHz

**LSD:**  $\frac{4 \text{ nsec}}{\text{Gate Time}} \times \text{FREQ}$ , rounded to nearest decade

**Resolution:** ± 1 LSD

$\pm \frac{(1.4 \times \text{Trigger Error} + 1 \text{ nsec rms})}{\text{Gate Time}} \times \text{FREQ}$

**Accuracy:** ± Resolution ± Time Base Error × Frequency

### PERIOD A

**Range:** 10 ns to .1 sec

**LSD Displayed:** .001 fs to 10 ns

**LSD:**  $\frac{4 \text{ nsec}}{\text{Gate Time}} \times \text{period}$ , rounded to nearest decade

**Resolution:** ± 1 LSD

$\pm \frac{(1.4 \times \text{Trigger Error} + 1 \text{ nsec rms})}{\text{Gate Time}} \times \text{period}$

**Accuracy:** ± Resolution ± Time Base Error × Period

### TIMEBASE (TCXO)

**Frequency:** 10 MHz

**Aging Rate:** <1 × 10<sup>-7</sup>/month

**Temperature:** <2 × 10<sup>-6</sup>, 0-40°C

(±1 × 10<sup>-8</sup>, 0-40°C if referenced to 25°C, and set to the offset frequency.) (See AN 200-2).

**Line Voltage:** <5 × 10<sup>-8</sup> for ±10% variation.

### OPTION 004, OVEN TIMEBASE

**Frequency:** 10 MHz

**Aging Rate:** <3 × 10<sup>-9</sup>/month, after 30 days of continuous operation.

**Temperature:** ±1 × 10<sup>-7</sup>, 0-50°C referenced to 25°C.

**Line Voltage:** <2 × 10<sup>-9</sup> for ± 10% variation

### HEWLETT-PACKARD INTERFACE BUS

**Programmable Functions:** Frequency A, Frequency B, Period A.

**Programmable Controls:** X20 Attn A, FILTER A, MAN LEVEL A, Gate Time.

**Display:** Normal, Increment, Decrement, (number of digits displayed); any 12 character message can be displayed on the LCD via a system controller.

**Misc. Functions & Operating Commands:** Diagnostics, 10 MHz Check, reset, initialize, Wait to send ON/OFF, Device ID.

**Interface Functions:** Device Clear, Group Execute Trigger, Interface Clear, Local, Local Lockout, Send Status, Remote, Service Request. SH1, AH1, T5, TE0, L4, LE0, SR1, RL1, PP0, DC1, DT1, C0, E1.

**Data Output:**

Output will be maximum resolution for the gate time selected and is not affected by the front panel Display Digits keys.

**Format:** 17 characters plus CR and LF (blanks may be inserted).

**Rate:** 4 readings/sec maximum at .1 sec gate

**Talk only:** Set with address switch=31

### GENERAL

**Check:** 10 MHz Self-test

**Gate Times:** 0.1, 1, or 10 seconds NOMINAL Accuracy: ±15% + up to 1 period of input signal

**Display:** 12-digit alphanumeric liquid crystal

**Display Digits (variable):** Frequency, 3 to 11; Period, 3 to 8

**Timebase Output:** 10 MHz 25 mV pk-pk NOMINAL into 50 Ω load.

**External Timebase Input:** 10 MHz, .5 Vrms into 500 Ω; 15 V (DC+AC pk) maximum.

**Operating Temperature:** 0°C to 50°C

**Power Requirements:**

**AC Operation:** Selectable, 30 VA maximum

115V + 10%, -25%: 48-66 Hz

230V + 10%, -15%: 48-66 Hz

115V + 10%, -10%: 380-420 Hz

**Weight:** Net, 3.4 kg (7 lbs. 8 oz.) Shipping 5.3 kg (11 lbs. 9 oz.)

**Dimensions:** 212.3 mmW × 88.1 mmH × 421.6 mmD (8 1/3 × 3 1/2 × 16 1/2 in.)

Table 1-1. Model HP 5386A Specifications (Continued)

### Definitions

**Measurement Gate Time:** selected value  $\pm 15\%$  + up to 1 period of input.

**Dynamic Range:** Minimum to maximum input voltage swing allowed for correct frequency counting.

**LSD Displayed:** dependent on gate time, input signal, and DISPLAY DIGITS control. In NORM mode, 8 digit are displayed. Using the display control, up to 11 digits may be present for frequency measurements, 8 digits maximum for period.

**LSD:** unit value of least significant digit rounded to the nearest decade, i.e. 4 Hz becomes 1 Hz, 6 Hz becomes 10 Hz.

**Trigger Error:**

**Channel A:**

$$\frac{\sqrt{(e_i)^2 + (e_n)^2}}{\text{Input slew rate at trigger point}} \quad \text{sec rms,}$$

where  $e_i$  and  $e_n$  are input noise voltages (rms) for the counter and signal, respectively, for a 100 MHz bandwidth.

$$e_i \leq 100 \mu\text{Vrms}$$

**Channel B:** negligible due to high signal slew rate at the trigger point.

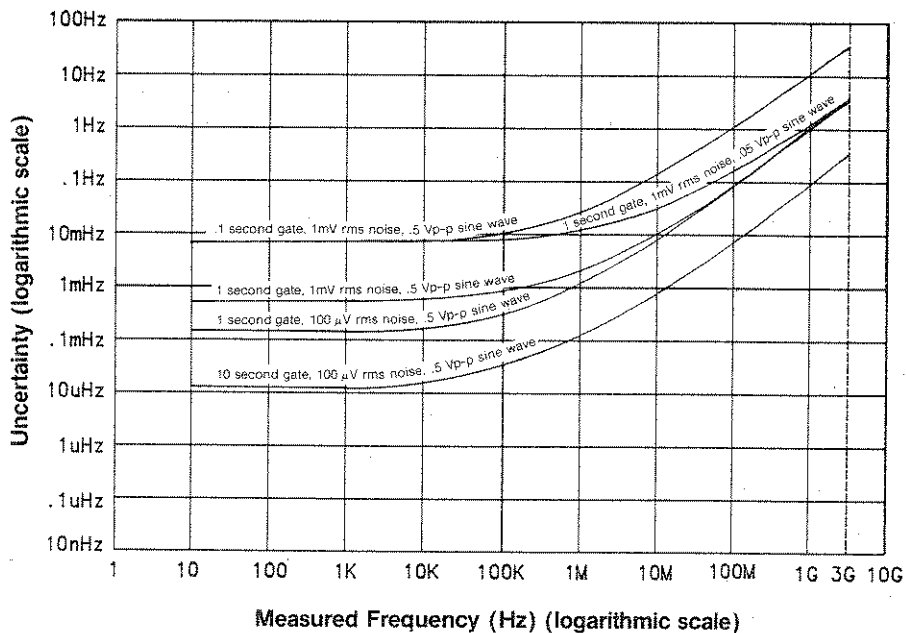

Figure 1. Uncertainties in frequency measurements result from noise on the input signal (trigger error). These uncertainties can be reduced by increasing the gate time, reducing the noise on the input signal, and increasing the input signal amplitude (increasing the slew rate).

Table 1-1. Model HP 5386A Specifications (Continued)

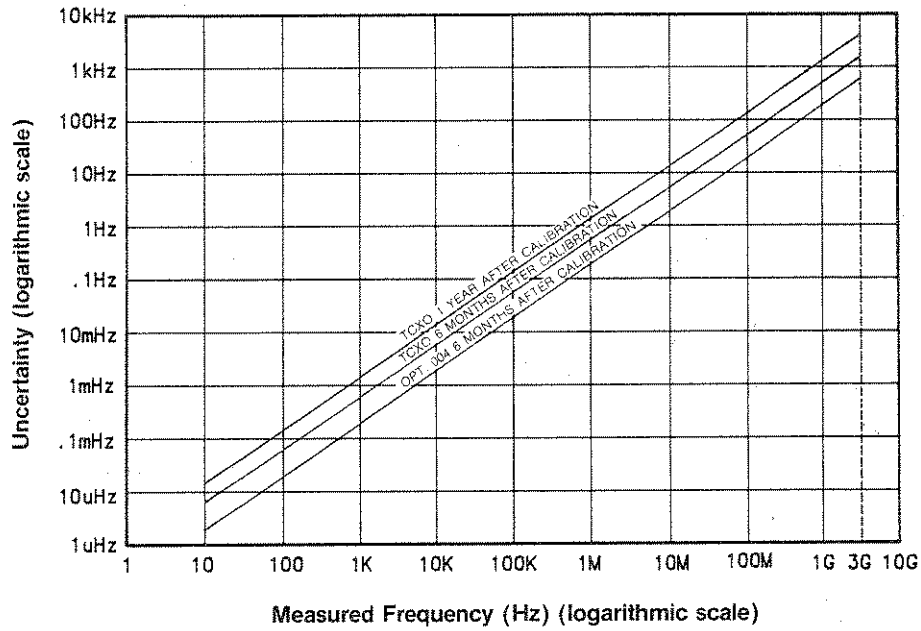

Figure 2. Aging of the counter timebase will contribute to the uncertainty of a frequency measurement. This uncertainty can be reduced by calibrating the timebase more frequently, or using a timebase with a better aging rate.

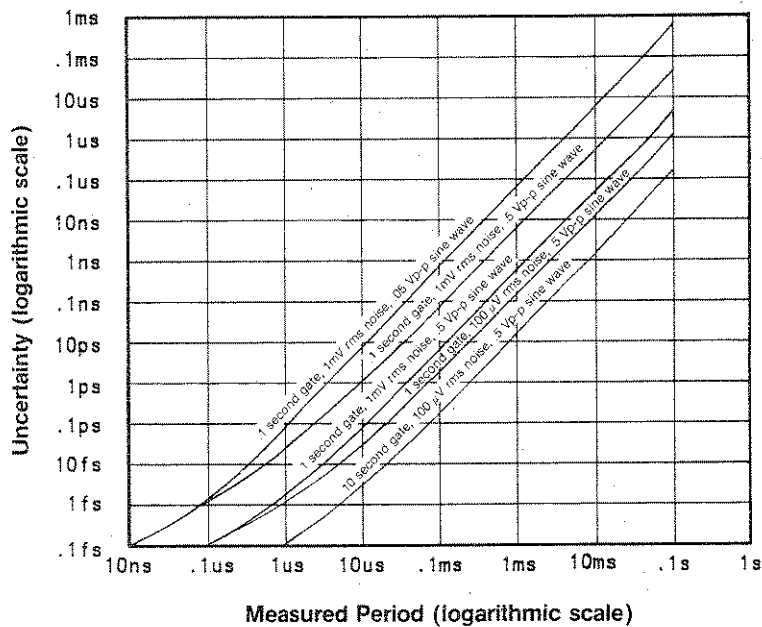

Figure 3. Uncertainties in period measurements result from noise on the input signal (trigger error). These uncertainties can be reduced by increasing the gate time, reducing the noise on the input signal, and increasing the input signal amplitude (increasing the slew rate).



Table 1-1. Model HP 5386A Specifications (Continued)

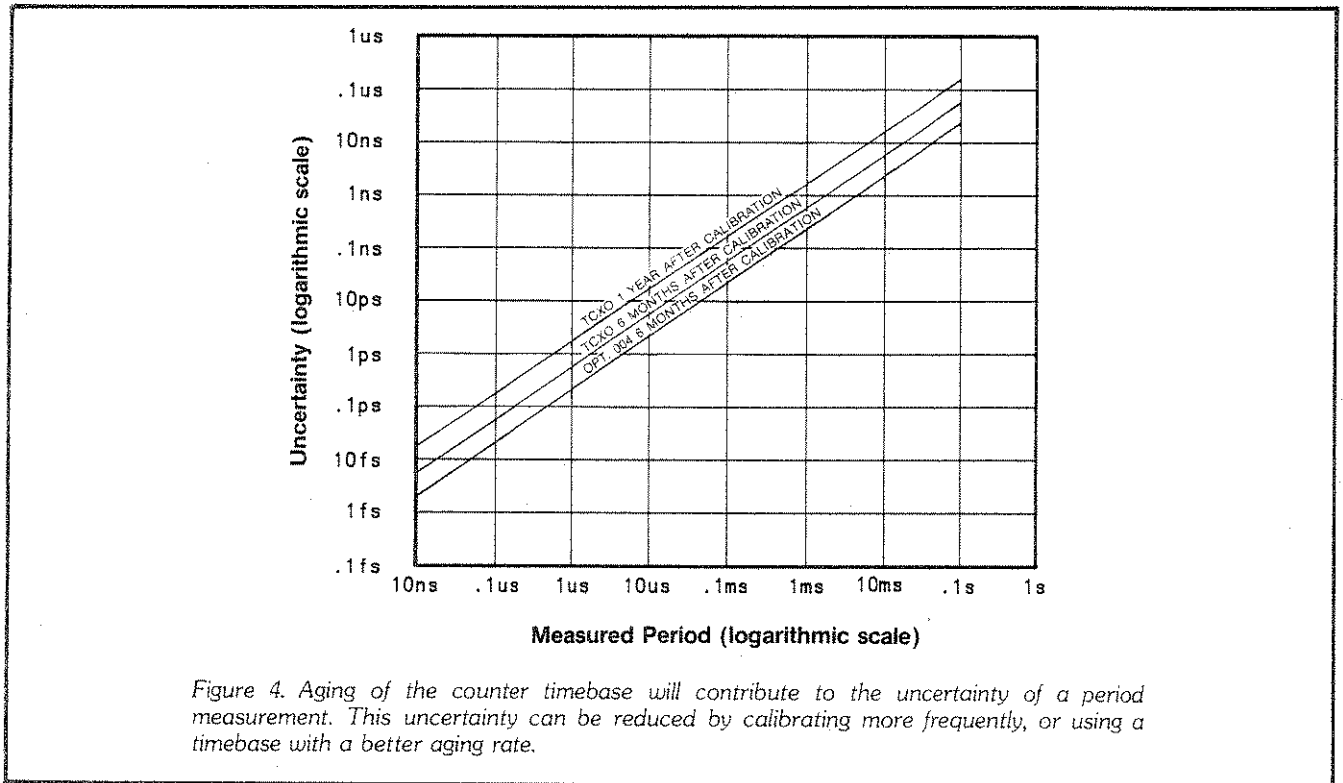

Table 1-2. Recommended Test Equipment

Instrument	Critical specifications	Recommended Model	Use
50 Ohm Feedthrough	BNC Type	HP 10100C	P,A,T
Tee Connector	BNC Type	HP 1250-0781	P,A,T
Cables	BNC 50 ohm	HP 11170C	P,A,T
Oscilloscope	100 MHz Bandwidth	HP 1740A	A,T
Synthesized Sweeper	10 MHz-26.5 GHz	HP 8340A/41A	P
Signal Generator	50-225 MHz	HP 8656A	P,A,T
Signal Generator	90-1000 MHz	HP 804A	P,T
Synthesized Function Generator	10 Hz to 20 MHz	HP 3325A	P,A,T
DC Voltmeter	20V Range, 0.05V resolution	HP 3465	A,T
Power Splitter	90 MHz-1 GHz Cal. output	HP 11667A	A,T
Power Meter/Sensor	90 MHz-1 GHz, -9 to -24 dBm	HP 436A/8481A	P
10 dB Attenuator		HP 8491A	P
Adapter, Coaxial (2 required)	Type N(male)-to-BNC(female)	1250-07680	P
Adapter, Coaxial	Type N(male)-to-BNC(male)	1250-0082	P
Controller	HP-IB Compatible	HP-85F*	
Resistor	10Ω 20W	0811-1655	A

\*HP-85F consists of the following:

Controller .....	HP-85A
I/O ROM .....	00085-15003
ROM Drawer .....	HP 82936A
HP-IB Interface Card/Cable .....	HP 82937A

## SECTION II INSTALLATION

### 2-1. INTRODUCTION

2-2. This section contains information for unpacking, inspection, storage, and installation.

### 2-3. UNPACKING AND INSPECTION

2-4. If the shipping carton is damaged, inspect the instrument for visible damage (scratches, dents, etc.). If the instrument is damaged, notify the carrier and the nearest Hewlett-Packard Sales and Service Office immediately (offices are listed at the back of this manual). Keep the shipping and packing material for the carrier's inspection. The Hewlett-Packard Sales and Service Office will arrange for repair or replacement of your instrument without waiting for the claim against the carrier to be settled.

### 2-5. PREPARATION FOR USE

#### CAUTION

Before connecting the instrument to ac power lines, be sure that the voltage selector is properly positioned as described below.

### 2-6. POWER REQUIREMENTS

2-7. The counter has the following ac power requirements:

- 115V, +10%, -25%, 48-66 Hz single phase
- 230V, +10%, -15%, 48-66 Hz single phase
- 115V, +10%, -10%, 380-420 Hz single phase

### 2-8. LINE VOLTAGE SELECTION

2-9. The power line voltage is selected by the position of the LINE SELECT switch on the rear panel. Sliding the switch to the left selects 115V operation, sliding the switch to the right selects 230V operation. The voltages available are printed on the switch. The specific voltage selected will be visible on the LINE SELECT switch, as shown in *Figure 2-1*. Before applying power, verify that the LINE SELECT switch is properly set for the desired ac supply voltage and that the correct fuse is installed.

### 2-10. AC Line Fuse Selection

2-11. The ac line fuse is accessible from the outside of the cabinet. To replace the ac fuse use a small, flat-

blade screwdriver to remove the fuse from the fuseholder. The correct fuse value is 250 mA/250V Slow Blow for 115V operation. For 230V operation, use 125 mA/250V Slow Blow.

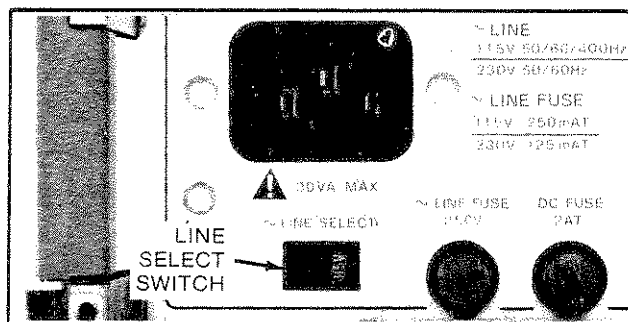

Figure 2-1. Line Voltage Selection

### 2-12. DC Fuse Selection

2-13. To replace the dc fuse use a small flat-bladed screwdriver to remove the fuse from the fuseholder. Press in slightly and turn counterclockwise, until the fuse carrier springs free. Replace the fuse in the fuse carrier and reinstall by inserting and turning clockwise. Be sure to install the correct fuse value; 2 AT Slow Blow.

2-14. The dc fuse is the main protective device for the instrument.

### 2-15. Power Cable

2-16. The counter is shipped with a three-wire power cable. When the cable is connected to an appropriate ac power source, this cable connects the instrument chassis to earth ground. The type of power cable plug shipped with each instrument depends on the country of destination. Refer to *Figure 2-2* for the part numbers of the power cable and plug configurations available.

#### WARNING

**BEFORE ENERGIZING THIS INSTRUMENT, THE PROTECTIVE EARTH TERMINAL OF THIS INSTRUMENT MUST BE CONNECTED TO THE PROTECTIVE CONDUCTOR OF THE (MAINS) POWER CORD. THE MAINS PLUG SHALL ONLY BE INSERTED IN A SOCKET OUTLET PROVIDED WITH A PROTECTIVE EARTH CONTACT. THE PROTECTIVE ACTION MUST NOT BE NEGATED BY THE USE OF AN EXTENSION CORD (POWER CABLE) WITHOUT A PROTECTIVE EARTH (GROUNDING) CONDUCTOR.**

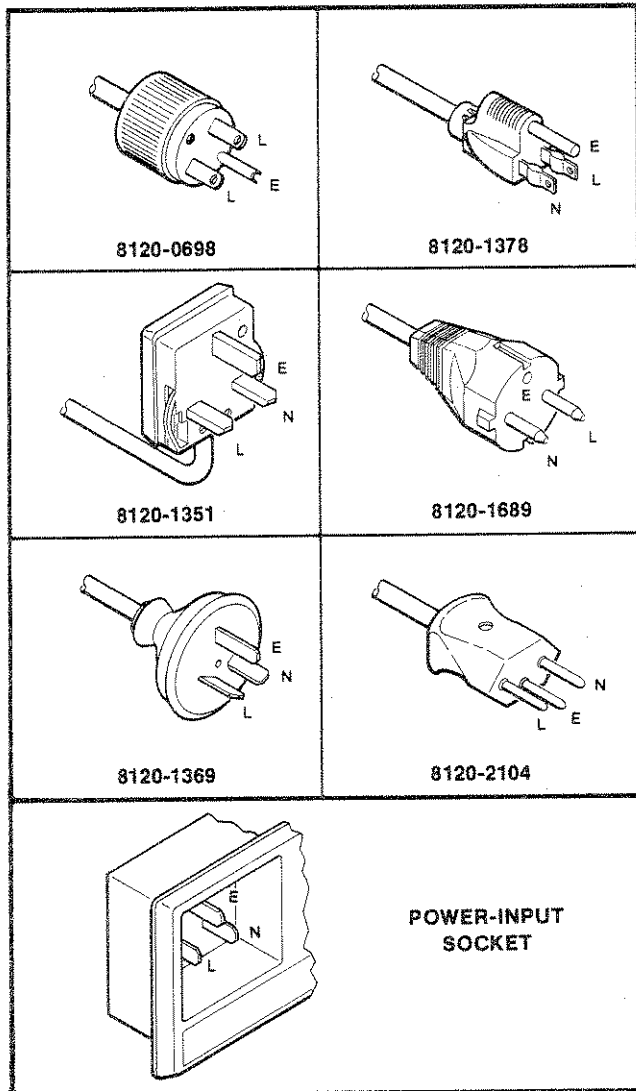

Figure 2-2. Power Cable HP Part Number versus Mains Plugs Available

### 2-17. HP-IB Interconnections

2-18. HEWLETT-PACKARD INTERFACE BUS. The counter with HP-IB is compatible with the Hewlett-Packard Interface Bus. Interconnection data concerning the rear panel HP-IB connector is provided in Figure 2-3. This connector is compatible with the HP 10833A/B/C/D cables. (See Table 2-1 for cable descriptions). The HP-IB system allows interconnection of up to 15 (including the controller) HP-IB compatible instruments.

Table 2-1. HP-IB Cable Descriptions

HP Model	Cable Length
10833A	1 metre (3.3 feet)
10833B	2 metres (6.6 feet)
10833C	4 metres (13.2 feet)
10833D	0.5 metres (1.6 feet)

2-19. The HP-IB cables have identical "piggy-back" connectors on both ends so that several cables can be connected to a single source without special adapters or switch boxes. System components and devices may be connected in virtually any configuration desired. There must, of course, be a path from the calculator (or other controller) to every device operating on the bus. As a practical matter, avoid stacking more than three or four cables on any one connector. If the stack gets too large, the force on the stack produces great leverage which can damage the connector mounting. Be sure each connector is firmly (finger tight) screwed in place to keep it from working loose during use.

2-20. CABLE LENGTH RESTRICTIONS. To achieve design performance with the HP-IB, the proper voltage levels and timing relationships must be maintained. If the system cable is too long, the lines cannot be driven properly, and the system will fail to perform properly. Therefore, when interconnecting an HP-IB system, it is important to observe the following rules.

- The total cable length for the system must be less than or equal to 20 metres (65.6 feet).
- The total cable length for the system must be less than or equal to 2 metres (6.6 feet) times the total number of devices connected to the bus.
- The total number of instruments connected to the bus must not exceed 15.

### 2-21. HP-IB Talk/Listen Address Switch

2-22. The HP 5386A provides a rear panel HP-IB instrument address selection switch. This switch determines the mode of remote operation as "Talk Only" or "addressable", and selects the HP-IB address. Instructions for changing the address are provided in Section III of this manual.

### 2-23. HP-IB Description

2-24. A description of the HP-IB is provided in Section III of this manual. A study of this information is necessary if the user is not familiar with the HP-IB concept. Additional information concerning the design criteria and operation of the bus is available in IEEE Standard 488-1978, titled "IEEE Standard Digital Interface for Programmable Instrumentation".



The above symbol when located in the upper corner of a page indicates HP-IB information is contained on that page. This information may be operation, performance, adjustments, or service related.



PIN	LINE
1	DIO1
2	DIO2
3	DIO3
4	DIO4
13	DIO5
14	DIO6
15	DIO7
16	DIO8
5	EOI
17	REN
6	DAV
7	NRFD
8	NDAC
9	IFC
10	SRQ
11	ATN
12	SHIELD-CHASSIS GROUND
18	P/O TWISTED PAIR WITH PIN 6
19	P/O TWISTED PAIR WITH PIN 7
20	P/O TWISTED PAIR WITH PIN 8
21	P/O TWISTED PAIR WITH PIN 9
22	P/O TWISTED PAIR WITH PIN 10
23	P/O TWISTED PAIR WITH PIN 11
24	ISOLATED DIGITAL GROUND

THESE PINS  
ARE  
INTERNALLY  
GROUNDED

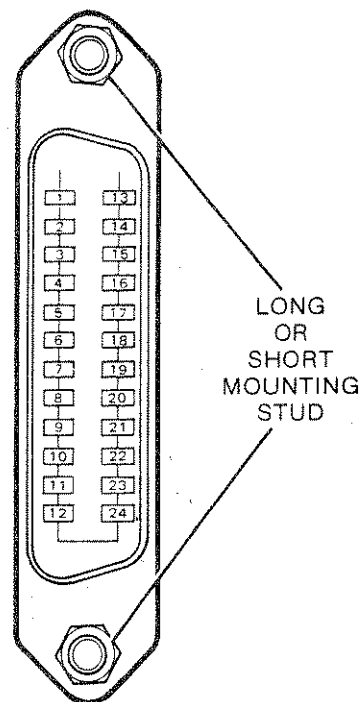

**CAUTION**

The HP 5386A contains metric threaded HP-IB cable mounting studs as opposed to English threads. Metric threaded HP 10833A, B, C, or D HP-IB cable lockscrows must be used to secure the cable to the instrument. Identification of the two types of mounting studs and lockscrows is made by their color. English threaded fasteners are colored silver and metric threaded fasteners are colored black. DO NOT mate silver and black fasteners to each other or the threads of either or both will be destroyed. Metric threaded HP-IB cable lockscrow illustration and part number follows.

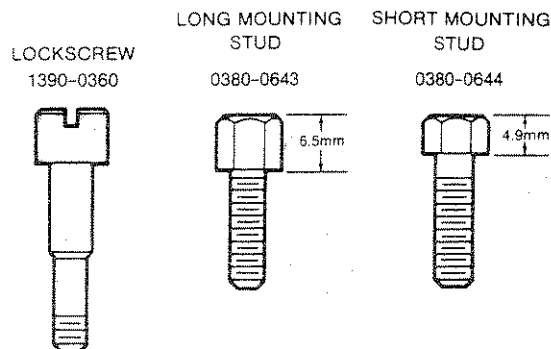

**Logic Levels**

The Hewlett-Packard Interface Bus logic levels are TTL compatible, i.e., the true (1) state is 0.0V dc to 0.4V dc and the false (0) state is +2.5V dc to +5.0V dc.

**Programming and Output Data Format**

Refer to Section III, Operation

**Mating Connector**

HP 1251-0293; Amphenol 57-30240.

**Mating Cables Available**

HP 10833A, 1 metre (3.3 ft.), HP 10833B, 2 metres (6.6 ft.),  
HP 10833C, 4 metres (13.2 ft.), HP 10833D, 1/2 metre (1.6 ft.).

**Cabling Restrictions**

1. A Hewlett-Packard Interface Bus System may contain no more than 2 metres (6.6 ft.) of connecting cable per instrument.
2. The maximum accumulative length of connecting cable for any Hewlett-Packard Interface Bus System is 20.0 metres (65.6 ft.).
3. The maximum number of instruments in one system is fifteen.

Figure 2-3. Hewlett-Packard Interface Bus Connections

## 2-25. Operating Environment

2-26. TEMPERATURE. The counter may be operated in temperatures from 0°C to +50°C.

2-27. HUMIDITY. The counter may typically be operated in environments with humidity up to 95% at 40°C. However, it should be protected from extreme temperatures which may cause condensation in the instrument.

2-28. ALTITUDE. The counter may be typically operated at altitudes up to 4,600 metres (15,000 feet).

## 2-29. STORAGE AND SHIPMENT

### 2-30. Environment

2-31. The instrument may be stored or shipped in environments within the following limits:

TEMPERATURE ..... -40°C to +75°C  
HUMIDITY .... Up to 95% noncondensing  
ALTITUDE ..... 15,240 Metres (50,000 feet)

2-32. The instrument should also be protected from temperature and humidity extremes which cause condensation within the instrument.

### 2-33. Packaging

2-34. ORIGINAL PACKAGING. Containers and materials identical to those used in the factory packaging are available through Hewlett-Packard offices. If the instrument is being returned to Hewlett-Packard for servicing, attach a tag indicating the type of service required, return address, model number, and full serial number. Also, mark the container FRAGILE to ensure careful handling. In any correspondence, refer to the instrument by model number and full serial number.

2-35. OTHER PACKAGING. The following general instructions should be used for repacking with commercially available materials.

a. Wrap the instrument in heavy paper or plastic. If you are shipping to a Hewlett-Packard office or service center, attach a tag indicating the type of service required, return address, model number, and full serial number.

b. Use a strong shipping container. A double-wall carton made of 350-pound test material is adequate.

c. Use a layer of shock-absorbing material 70 to 100 mm (3- to 4-inch) thick around all sides of the instrument to provide firm cushioning and prevent

movement inside the container. Protect the control panel with cardboard.

d. Seal the shipping container securely.

e. Mark the shipping container FRAGILE to ensure careful handling.

f. In any correspondence, refer to the instrument by model number and full serial number.

## 2-36. WHERE TO SHIP YOUR UNIT FOR REPAIR

2-37. Return your unit to the nearest designated Hewlett-Packard Sales and Support Office. Check the back of this manual for the address.

## 2-38. FIELD INSTALLATION OF OPTION 004

2-39. The following information provides instructions for installation of option 004 for the HP 5386A.

2-40. Refer to *Table 2-2* for a list of the parts required for installation of option 004.

*Table 2-2. Required Parts for Field Installation of Option 004*

Opt.	Ref. Des.	Description	Pt. No.
004	Y1B	10 MHz Oven Oscillator Module	0960-0636
	R96	121 ohm	0757-0403

### 2-41. Option 004 Oven Oscillator Installation

2-42. The Option 004 Oven Oscillator replaces the TCXO in the 5386A. To install the Option 004 proceed as follows:

a. Remove ac power cord.

b. Loosen screw on top cover at rear of instrument.

c. Slide cover toward rear of counter, lift off.

d. Loosen screw on bottom cover at rear of instrument.

e. Lift instrument from bottom cover.

f. Remove HP-1B board for access to TCXO.

g. Unsolder and remove TCXO.

h. Install oven oscillator Y1B and 121 ohm resistor in R96 position.

i. Refer to Section V for the oscillator adjustment procedure.

j. Reassemble the counter by following steps "a" through "i" in reverse order.

## SECTION III OPERATION AND PROGRAMMING

### 3-1. INTRODUCTION

3-2. This section gives complete operating and programming information for the HP 5386A Frequency Counter. Descriptions of all front panel controls, connectors, and indicators, as well as an operator's check, operating instructions, programming instructions and codes, and operator's maintenance, are provided.

### 3-3. OPERATING CHARACTERISTICS

3-4. The HP 5386A can be configured for system or benchtop use. The counter makes frequency and period measurements. Inputs enter through two channels. Raw data from the input measurements are used by the counter's microcomputer to compute and format the result either for display or transmission over the HP-IB. The operating range, resolution and accuracy for each functional mode is given in the Specifications, *Table 1-1*.

3-5. Descriptions of and operating instructions for Option 004 is provided in this section.

### 3-6. OPERATING INSTRUCTIONS

3-7. Information and instructions for operating the HP 5386A in both local and remote modes are provided in this section. The following paragraphs summarize the organization and content of the operating information.

3-8. LOCAL OPERATION. The operating information for local (or manual) operation of the counter consists of the following topics:

General Operation Information. The General Operation Information describes the basic operation of the instrument display, the inputs, and the front panel keyboard.

Front and Rear Panel Features. The front and rear panel features consists of *Figures 3-7* through *3-9* which locate and describe all the operator controls and indicators.

Making Frequency and Period Measurements. Making Frequency and Period Measurements describes the recommended procedure for making a measurement.

3-9. REMOTE OPERATION. A good working knowledge of the local operation of the counter is essential

for remote programming, as most of the data messages perform the same key-stroke-like sequences. The Remote Operation/Programming instructions describe the following:

- Interface Description
- Interface Functional Overview
- Interface System Overview
- Address Selection
- Interface Function
- Interface Commands
- Input Format
- Output Format
- Measurement Triggering in Remote
- SRQ, SRQ Mask, and Status Byte
- Device Dependent Commands
- Device Command Definitions
- Power-up and Default States
- Programming Examples

### 3-10. OPERATOR'S MAINTENANCE

3-11. The only maintenance the operator should normally perform is the replacement of either fuse. Refer to Section II, Line Voltage Selection, for instructions on changing the fuses.

3-12. TCXO adjustment is also accessible from the rear panel. The oscillator is factory set at 10 MHz. Once adjusted, the oscillator should need little future attention except for periodic calibration using a precision frequency source. To adjust the oscillator, refer to Section V.

### 3-13. GENERAL OPERATION INFORMATION

#### 3-14. Introduction

3-15. The following paragraphs describe the general operating features of the HP 5386A Frequency Counter.

#### 3-16. Display

3-17. All display functions are performed by a Liquid Crystal Display assembly. The assembly contains 12 alphanumeric characters; the display format for all measurements is in engineering notation. The leftmost character is CHARACTER 1 and the rightmost is CHARACTER 12. The scale or units designation will normally be shown in character positions 10, 11, and 12. If positions 10 and 11 are required to display a high resolution measurement, only character position 12 will be used to designate the scale or units.

3-18. Annunciation for all operating modes is also indicated by the display. When a mode is selected, an arrow appears at the bottom of the display just above the name of the mode label on the front panel.

### 3-19. Keyboard

3-20. The keyboard, located on the front panel, is a 14-position pushbutton assembly which is connected to a port on the microcomputer. The keyboard is divided into several groups, according to the purpose of the keys. From the left after the power switch, is the A, B, GATE, and DISPLAY DIGITS keys.

3-21. A blue RESET/LOCAL key and the CHECK key complete the keyboard assembly of the counter.

### 3-22. INPUTS

3-23. Immediately to the right of the keyboard is the INPUTS section. There are two inputs (Channels A and B) and a control for adjusting the trigger level of Channel A. Channel A has a female BNC connector and Channel B has a female type N connector.

### 3-24. Power-Up/Self-Check

#### WARNING

**BEFORE USING THE INSTRUMENT, ALL PROTECTIVE EARTH TERMINALS, EXTENSION CORDS, AUTOTRANSFORMERS AND DEVICES CONNECTED TO IT SHOULD BE CONNECTED TO A PROTECTIVE EARTH GROUNDED SOCKET. ANY INTERRUPTION OF THE PROTECTIVE EARTH GROUND WILL CAUSE A POTENTIAL SHOCK HAZARD THAT COULD RESULT IN PERSONAL INJURY.**

#### CAUTION

**Before energizing the counter, the instrument must be set to the voltage of the power source or damage to the instrument may result. See Section II.**

3-25. When you power-up the counter, an internal check is automatically made of several major components in its circuitry. During this cycle, all 12 Liquid Crystal Display (LCD) digits will be momentarily activated in a starburst pattern. Also activated are the colons and annunciators. The address of the interface will briefly be displayed.

3-26. After the power-up sequence, the counter initializes itself. That is, Frequency A mode is selected for

display and the preset trigger level mode is selected. The ATTN and LPF modes are disabled, and the gate time is set to 0.1 s. If no input signal is present after the Power-Up cycle, 00000000 will appear on the display. The power-up initialize state is listed in *Table 3-1*.

*Table 3-1. Power-Up Initialize States*

FUNCTION	STATE
REMOTE/LOCAL	LOCAL
GATE TIME	0.1 s
MANUAL LEVEL	OFF
WAIT-TO-SEND	OFF
DISPLAY DIGITS	NORMAL
FUNCTION	FREQ A
X20 ATTN	X1
FILTER	OFF
REMOTE DISPLAY	OFF

3-27. Any failure during the power-up cycle will cause an error message to be displayed momentarily. After the error is displayed, the counter will attempt to operate normally.

### 3-28. Error Messages

3-29. The counter will display error messages whenever the instrument enters an error state. Errors can occur either during self-test or after an improper operation has been attempted through the interface.

3-30. If an error occurs during power-up self-test, error messages will appear on the display. The message will be displayed for approximately one second to give the operator sufficient time to read the message. One second after the error is displayed, the counter will attempt to operate normally.

3-31. If an error occurs during the power-up self-test, the ERROR annunciator will be turned on. This annunciator will stay on as long as the instrument does not enter the diagnostic mode to warn the operator of potentially inaccurate results.

3-32. Several types of errors can occur when an improper operation is attempted through the interface. Whenever an error message is generated because of an illegal operation, the error message will be displayed until the RESET/LOCAL key is pressed or a DCL (device clear) command is sent to the counter by the controller.

3-33. Illegal commands can either be commands not recognizable to the counter or commands which are recognizable, but are invalid if the counter is in the diagnostic or talk only modes.

3-34. Instrument error messages are listed in Table 3-2.

Table 3-2. Error Messages

Error	Messages
10	Self-test error
50	Unrecognizable mnemonic in command
51	Illegal numeric in command
52	First character of command is illegal
53	Illegal character in the "DR" (remote display) command
55	Invalid HP 5386A command protocol or frame error
56	Invalid diagnostic command
60	ROM failure in I/O processor
61	RAM failure in I/O processor
70	Controller connected to talk-only instrument

### 3-35. FRONT PANEL FEATURES

3-36. The front panel controls, indicators, and connectors are shown in Figures 3-7 through 3-9.

3-37. The following paragraphs describe the general purpose and use of the operator keys and controls. They are discussed by functional grouping, as follows:

- a. ON/STBY
- b. A CHANNEL
- c. B CHANNEL
- d. GATE and DISPLAY DIGITS
- e. RESET/LOCAL and CHECK
- f. INPUTS

### 3-38. POWER ON/STBY

3-39. The ON/STBY switch connects or disconnects the output from the +5-volt supply to the rest of the instrument. It does not control the ac power line at the primary of the power transformer. If Option 004, the ovenized oscillator is installed, +5 volts is supplied to the oscillator whether the power switch is in the STBY (standby) mode or in the ON mode (with the ac power cord connected). Figure 3-1 shows the ON/STBY switch.

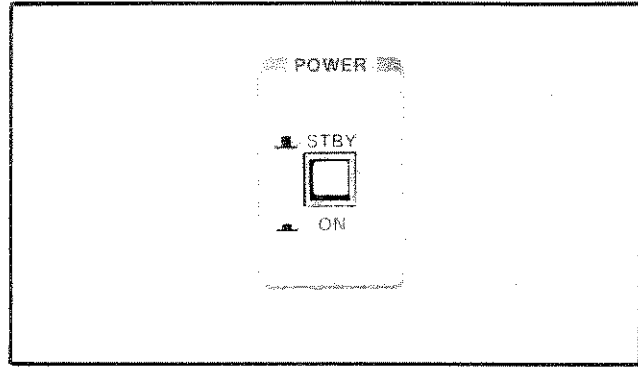

Figure 3-1. Front Panel ON/STBY Switch

### 3-40. A CHANNEL

3-41. Function selection for the HP 5386A is accomplished through a simple one key per function keyboard. You may select from five function modes (labeled in black) accessible from the five keys grouped under A. The arrows appearing in the bottom of the display identifies which functions are active. The five functions in the A channel group are: FREQ, X20 ATTN, PER, FILTER, MAN LEVEL. Refer to Figure 3-2, Front Panel A Channel Function Keys.

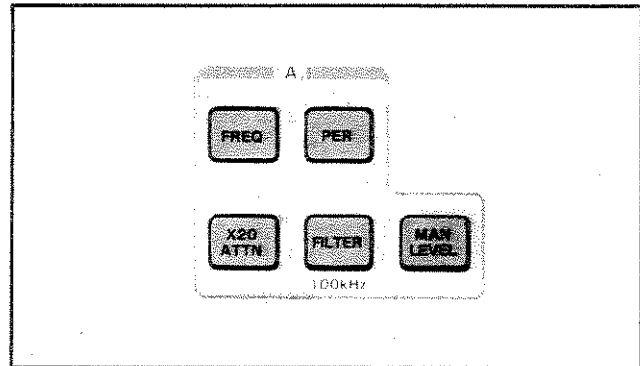

Figure 3-2. Front Panel A Channel Function Keys

3-42. FREQ key selects the frequency mode of operation for the A channel input. The frequency range of Channel A is 10 Hz to 100 MHz. When Channel A is selected, a black arrow appears in the bottom of the LCD over the "A" label located directly below the display window. The frequency at input A is measured and displayed.

3-43. If the counter has just been powered-up, Channel A is automatically selected (initialize mode) with a gate time of 0.1 s. If the counter has been operated since being powered-up, the frequency measurement is made using the last gate time selected.



3-44. PER key selects the period mode of operation for the Channel A input. When the PER key is pressed, the period of the signal at input A is measured. The measurement is automatically made using the last gate time selected. The gate time is displayed in the right side of the LCD. As in frequency measurements, the resolution of the measurement is affected by the gate time, since the HP 5386A is a reciprocal counter.

3-45. Reciprocal counters use the gate time to accumulate events (cycles of input signal) during the length of the gate time. The gate time is divided by the number of events (by the microcomputer) to determine the average period of the signal. The longer the gate time, the larger the number of events are accumulated. An increased number of accumulated events will increase the resolution of the measurement.

3-46. X20 ATTN key provides attenuation of the input signal on Channel A by a factor of approximately 20. Each press of the X20 ATTN key toggles between enabling and disabling an attenuation circuit. When a black arrow appears in the LCD above the "ATTN" label, the signal is attenuated. When no arrow appears, the signal is not attenuated.

3-47. The X20 ATTN sets the sensitivity of the Channel A input to either 15 mV rms or 300 mV rms range if the MANUAL LEVEL A control (discussed later) is in midrange position or disabled. The X20 ATTN operates independently of the front panel key MAN LEVEL. When the MAN LEVEL key is enabled, the X20 ATTN function will cause the range of the MANUAL LEVEL A control to increase approximately 20 times.

3-48. The FILTER key provides a 100 kHz Low Pass Filter that can be toggled into or out of the Channel A signal path. The Low Pass Filter will attenuate frequencies above 100 kHz. When the FILTER is in the signal path, a black arrow will appear in the LCD above the label "FILT".

3-49. The FILTER will improve the accuracy and resolution of frequency measurements below 100 kHz by blocking high frequency signals and noise that may be riding on the low frequency being measured.

3-50. MAN LEVEL key enables or disables the front panel MAN LEVEL A control in the INPUTS section.

3-51. When the MAN LEVEL A control is enabled (on), an arrow will appear in the LCD above the (MAN LVL A) label. The trigger level of channel A becomes manually variable. Channel B is not affected by the MAN LEVEL A control.

3-52. When the MAN LEVEL A control is disabled (off), the MANUAL LEVEL A control has no effect on input sensitivity of either channel.

### 3-53. B CHANNEL

3-54. Figure 3-3 shows the front panel B channel function key. The FREQ key selects the frequency mode of operation for the B Channel input for display on the LCD. Channel B frequency range for the HP 5386A is 90 MHz to 3 GHz.

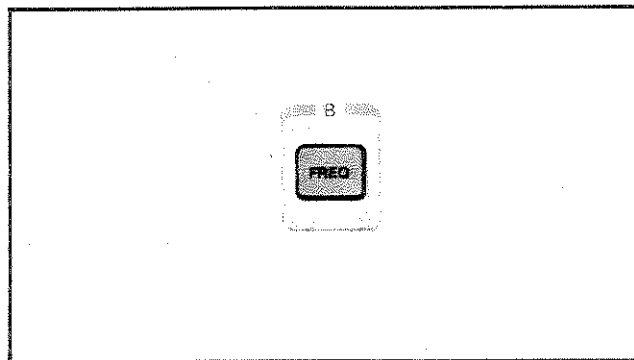

Figure 3-3. Front Panel B Channel Function Key

3-55. When channel B is selected, a black arrow appears in the bottom of the LCD over the "B" label located directly below the display window.

### 3-56. GATE and DISPLAY DIGITS

3-57. The GATE keys are shown in Figure 3-4. The GATE keys select the approximate gate time in decade ranges. The actual gate time is determined by the microcomputer.

3-58. The 0.1 s, 1.0 s, and 10 s keys select gate times from 0.1 second to 10 seconds for frequency, period and check measurements.

3-59. The greater the gate time the greater the accuracy and the number of digits of resolution you may obtain.

- 0.1 s 3 to 8 digits
- 1.0 s 3 to 9 digits
- 10 s 3 to 10 digits

If the most significant digits of a measurement are between 1.0 and 1.299... one extra digit is displayed, giving a maximum of 11 digits.

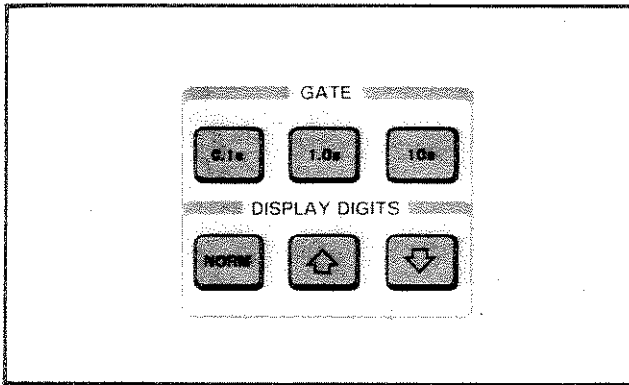
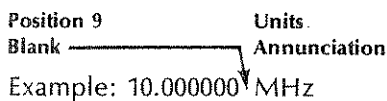

Figure 3-4. Front Panel GATE Select DISPLAY DIGITS Keys

3-60. The DISPLAY DIGITS keys are shown in Figure 3-4. They select the number of digits displayed on the LCD. However, these keys do not affect the resolution of the measurement sent over the interface bus. Measurements are always sent with maximum resolution over the interface.

3-61. NORM key selects the normal display resolution of eight digits and a three letter units annunciation.

3-62. The measurement display will begin on the left of the LCD (character position 1) and occupy the eight leftmost character positions. The three rightmost digits (character positions 10, 11, and 12) are used for units annunciation. Character position nine is left blank.



3-63. ↑ key will cause the number of digits displayed to increase to eight maximum for period measurements and 11 for frequency measurements. One press of the key causes one increment increase in the digits displayed. When more than eight digits are displayed, the scale annunciation is reduced to only one character.

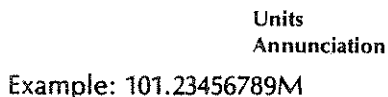

3-64. This key will not affect the data sent over the interface. The counter will not display digits beyond the calculated LSD. That is, if you ask for 11 digit resolution, you may get 7, 8, 9, 10, or 11 digits.

3-65. ↓ key will cause the number of digits displayed to decrease to a minimum of three digits. One press of

the key decreases the number of digits displayed by one digit.

6-66. Changes do not show on the display until completion of the next gate cycle, which could be up to 10 seconds. A new gate cycle is initiated when any key on the front panel is pressed. So, pressing any key on the front panel may cause a delay of up to 10 seconds before you will see the expected change in the display.

### 3-67. RESET/LOCAL and CHECK

3-68. The RESET/LOCAL and CHECK keys are shown in Figure 3-5.

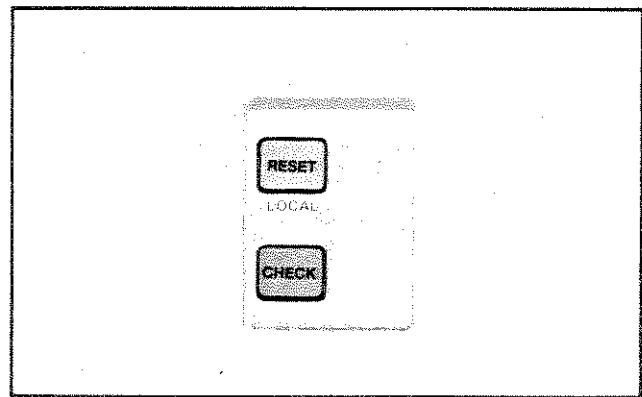

Figure 3-5. Front Panel RESET/LOCAL and CHECK Keys

3-69. When the counter is in the remote state and the local lockout (LLO) is not enabled, pressing the blue RESET/LOCAL key will return the counter to local keyboard control. The REM (remote) indicator arrow at the bottom left of the display will disappear. All functions and controls previously selected remain and a new measurement is initiated with the display reset to "00000000". If LLO is active, the RESET/LOCAL key as well as all other front panel keys are disabled.

3-70. If diagnostics are being executed while the counter is in either the local or remote state and the RESET/LOCAL key is pressed, the counter exits the diagnostic mode and defaults to the initialize mode of local operation.

3-71. If the counter is in local and not executing diagnostics, pressing the RESET/LOCAL key resets the display and initiates a new measurement.

3-72. The CHECK key is used to initiate tests that verify proper operation of the oscillator, shift register, microcomputer, display operation, and other hardware.

### 3-73. INPUTS

3-74. The INPUTS section consists of two input connectors and a MANUAL TRIG LEVEL single-turn potentiometer that controls the trigger level for channel A. Figure 3-6 shows the INPUTS section.

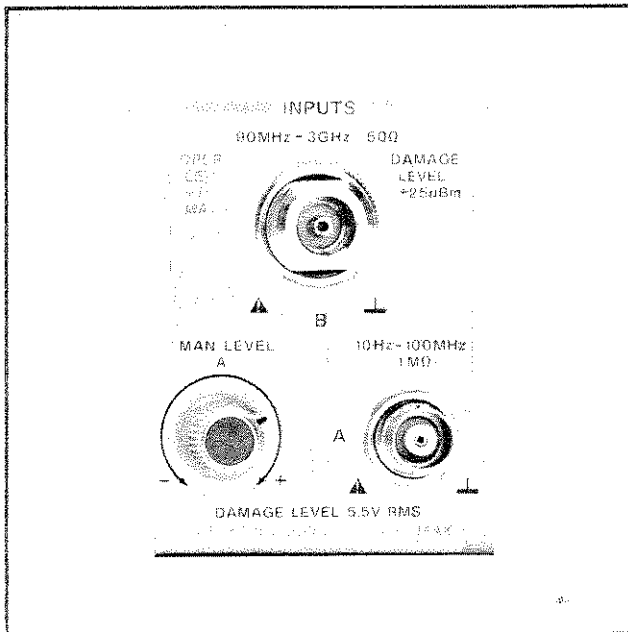

Figure 3-6. Front Panel INPUTS Section

3-75. Signals to be measured are connected to either channel A or channel B input connectors.

3-76. When the MANUAL LEVEL A control is enabled, Channel A trigger level is manually variable. Channel B is not affected. See the specifications in Section I.

3-77. MANUAL LEVEL A is enabled or disabled by the MAN LEVEL key. When disabled, the MANUAL LEVEL A control has no effect on input sensitivity of Channel A or B. Channel A sensitivity is maximum and Channel B sensitivity is controlled by an automatic gain control circuit. After power-up, the control is automatically disabled (initialize mode).

3-78. When the MANUAL LEVEL A control is enabled, an arrow will appear on the LCD above the label MAN LVL. The DC offset level of Channel A input is manually variable. A variable DC offset has the effect of being a polarity and trigger level control. When the X20 ATTN is disabled, the trigger level of input A may be set from  $-0.1$  volts to  $+0.1$  volts peak. At midrange,  $0.0$  volt level, Channel A input sensitivity will be approximately  $15$  mV rms or  $\pm 21$  mV peak. If the X20 ATTN is enabled, these values increase by a nominal factor of 20.

3-79. There are two input connectors; Channel A and Channel B. Channel A input frequency range is from  $10$  Hz to  $100$  MHz. Channel B input frequency range is  $90$  MHz to  $3$  GHz.

3-80. Both inputs are ac coupled with dc blocking up to  $350$  Vdc for Channel A and  $5$  Vdc for Channel B.

### 3-81. REAR PANEL FEATURES

3-82. A number of signal inputs, outputs, connectors and controls are provided on the rear panel. Figure 3-9 shows the rear panel.

3-83. The Input/Output interface connector provides remote control capabilities with the Hewlett-Packard Interface Bus (HP-IB).

3-84. The interface address switch (ADDR) is a seven-position switch that is used to manually set the remote control address of the counter. The five rightmost switch positions are externally accessible and can be used by the operator for setting the address. The two leftmost switch positions are not used for normal operation. For a complete description of address selection, refer to Table 3-4, Address Selection, in the Remote Programming Instructions in this section.

3-85. The HP-IB capabilities of the counter is listed above the interface port. For a complete description of the listed capabilities, refer to paragraph 3-112, Interface Commands.

3-86. The AC LINE INPUT connector accepts the ac input power cord. The protective grounding conductor also connects to the instrument through the ac power connector.

3-87. The LINE SELECT switch selects the instrument line voltage. The switch selects either  $115$  or  $230$  volts. The number visible on the switch indicates the nominal line voltage to which the instrument must be connected for proper operation.

3-88. The DC FUSE is a two-ampere slow-blow fuse for the protection of the dc power supply to the instrument. The dc fuse is the main protection for the counter. The ac fuse is a  $.25$  ampere slow blow type that protects the transformer against overvoltage.

3-89. The  $10$  MHz IN/OUT BNC connector provides a  $10$  MHz signal that may be used for calibration when the INT EXT switch is in the INT position. When the INT EXT switch is in the EXT position, the IN/OUT BNC



connector becomes the external reference input for the counter.

### 3-90. MAKING FREQUENCY AND PERIOD MEASUREMENTS

3-91. The recommended sequence for setting-up and making a measurement with the HP 5386A Frequency counter is given below.

- a. Set the power switch to ON. The counter should perform a power-up self-check, then preset to the power-up initialize settings shown in Table 3-1.
- b. Press the key for the desired operating mode (frequency, period etc.).
- c. Connect a signal into the channel selected.
- d. If the display is unstable, use the attenuator, filter, or manual trigger level control and adjust for a stable reading. The above mentioned controls have limitations. They cannot compensate for excessively noisy or unstable signal sources.
- e. If desired, select a gate time and the number of display digits desired.

#### NOTE

The display for frequency measurements of less than 1 Hertz will have a "less than" symbol (<) on the left of the Hertz symbol (Hz). Refer to Table 3-3.

Table 3-3. Units Display Format

FUNCTION	UNITS	
	<=8 DIGITS	>8 DIGITS
FREQUENCY A/ FREQUENCY B	< HZ HZ KHZ MHZ GHZ	< H K M G
PERIOD A	KSC SEC MS US NS	
CHECK	MHZ	M

### 3-92. REMOTE PROGRAMMING

#### 3-93. Introduction

3-94. The HP 5386A frequency counter is compatible with the Hewlett-Packard Interface Bus. Remote programming allows the instrument to respond to

remote control instructions and output measurement data via the interface. At the simplest level, the counter can output data in the talk only mode to other devices such as a printer. In more sophisticated systems, a controller can remotely program the counter to perform a specific type of measurement, trigger the measurement, and output the results.

#### NOTE

HP-IB is Hewlett-Packard's implementation of IEEE Std. 488-1978, "Standard Digital Interface for Programmable Instrumentation".

3-95. To remotely program the counter efficiently, the operator must be familiar with the selected controller and the local (manual) operation of the counter. Typical controllers for the HP-IB are the HP 9825A/B, HP 9826A, HP 9830A, HP 9835/45A, or HP 85A. Users of the HP-IB interface should find the following manuals useful background information:

Condensed Description of the Hewlett-Packard Interface Bus (P/N 59401-90030)

HP-IB programming Hints for Selected Instruments (P/N 59300-90005)

Tutorial Description of the Hewlett-Packard Interface Bus (P/N 5952-0156)

### 3-96. INTERFACE DESCRIPTION

#### 3-97. Hewlett-Packard Interface Bus (HP-IB)

3-98. The Hewlett-Packard Interface Bus (HP-IB) system utilizes a party-line bus structure (devices share signal lines) to which a maximum of 15 devices may be connected in one continuous bus. Sixteen signal lines and 8 ground lines are used to interconnect devices in parallel arrangement and maintain an orderly flow of device and interface related information.

#### 3-99. INTERFACE FUNCTIONAL OVERVIEW

3-100. Each device on the interface may possess one or more of the following major device capabilities: Controller, Talker, or Listener. The controller, as the name implies, has the responsibility to control interface activity. The controller, of course, must be equipped with the proper interface module. Controllers transmit all device independent commands to other devices in the interface and usually have Talker and Listener capabilities. The counter cannot serve as a controller.

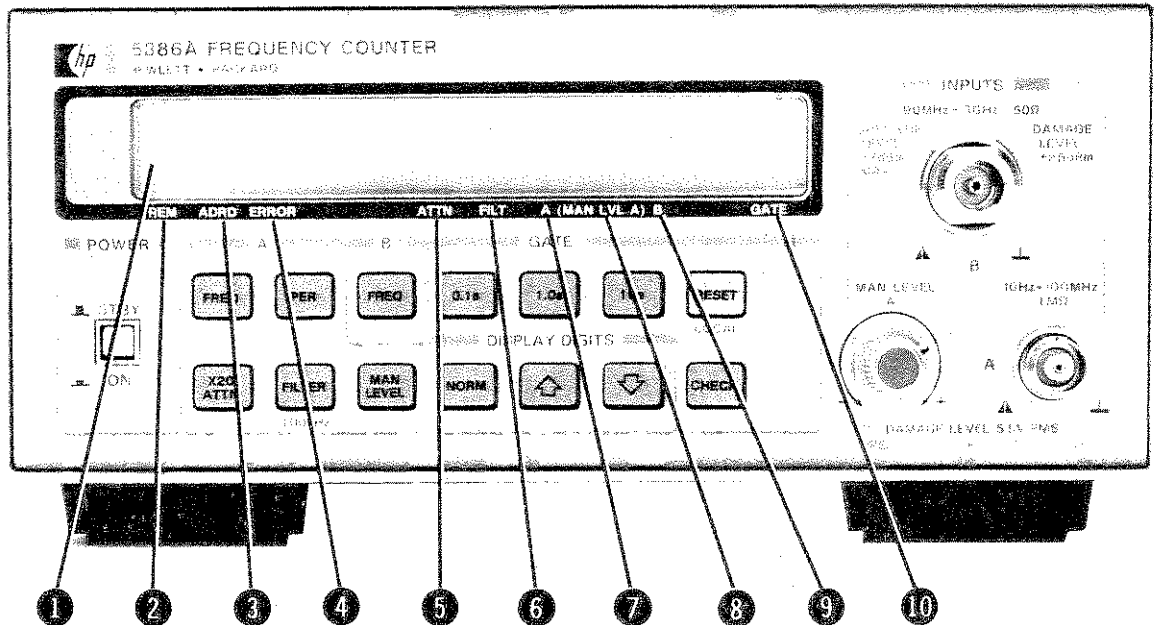

- ① **DISPLAY** The liquid Crystal Display contains the 12-digit, 14-segment display.
- ② **REM** An arrow appears above the REM (remote) label indicating the counter is in remote operation. The arrow does not appear in local operation.
- ③ **ADDR** An arrow appears above the ADDR (addressed) label indicating the counter is addressed by the controller. When the counter is addressed it may or may not be in remote operation.
- ④ **ERROR** An arrow appears above the ERROR (error) label when a failure occurs in the micro-processor. All other failures will cause an error number ("Ernn") to appear in the display.
- ⑤ **ATTN** An arrow appears above the ATTN (attenuator) label when the X20 attenuator is in the Channel A signal path.
- ⑥ **FILT** An arrow appears above the FILT (filter) label when the 100 kHz low pass filter is in the A Channel signal path.
- ⑦ **A** An arrow appears above the "A" label when the counter is set-up to make a frequency measurement or period measurement on Channel A.
- ⑧ **MAN LVL A** An arrow appears above the (MAN LVL A) label when the MANUAL LEVEL control is enabled.
- ⑨ **B** An arrow appears above the "B" label when the counter is set up to make a frequency measurement on Channel B.
- ⑩ **GATE** An arrow appears above the GATE label to indicate that a measurement is in progress.

Figure 3-7. Front Panel Indicators

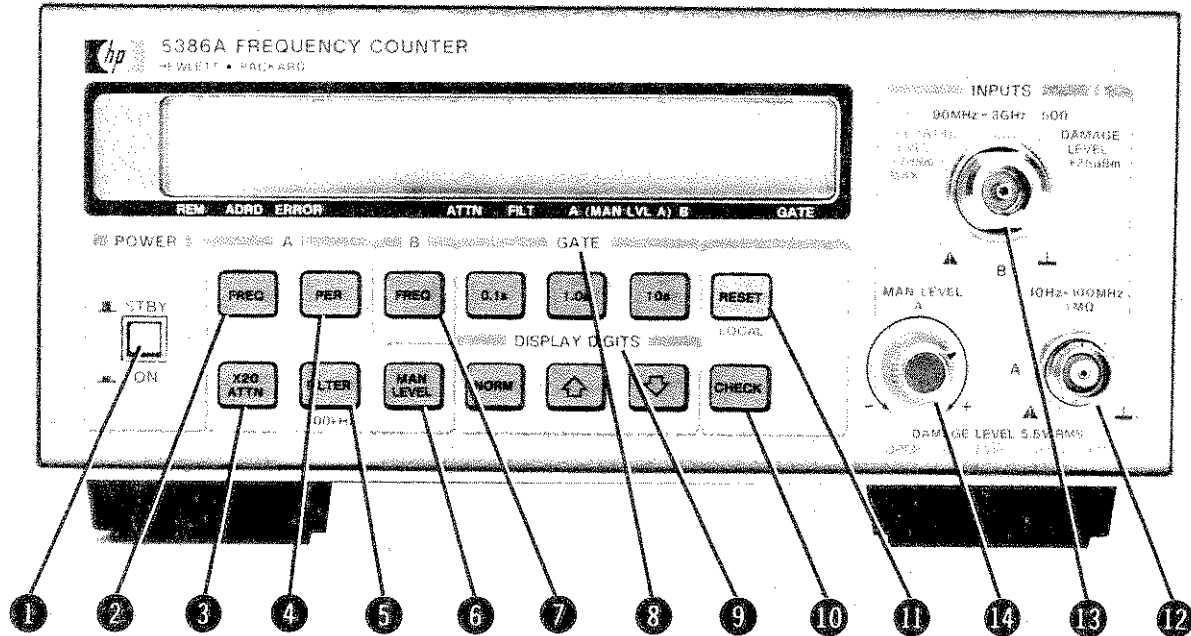

- ① STBY/ON The switch connects or disconnects the output of the +5 volt power supply to the rest of the instrument. Does not control the AC line.
- ② (A) FREQ The key selects the frequency mode of operation for channel A. Max. display digits: 11; Min. 3
- ③ X20 ATTN Enables or disables a X20 attenuator in the channel A input.
- ④ (A) PER The key selects the Period measurement mode of Channel A. Max. display digits: 9; Min. 3.
- ⑤ (A) FILTER 100 kHz The key switches the 100 kHz Low Pass Filter in or out of the Channel A signal path.
- ⑥ MAN LEVEL The key enables or disables the front panel MANUAL LEVEL A control.
- ⑦ (B) FREQ The key selects Channel B frequency mode for measurement.
- ⑧ GATE The three GATE keys select ranges of gate times.
- ⑨ DISPLAY DIGITS These keys are used to change the resolution of the display. NORM (normal) displays eight digits. The ↑ key increases the number of display digits to a maximum of 11 and the ↓ key decreases the number of display digits to a minimum of 3 in frequency mode.
- ⑩ CHECK The CHECK key is used to verify proper operation of the oscillator, count logic, micro-processor and the display. The correct display is 10 MHz ±1 least significant digit.
- ⑪ RESET/LOCAL In LOCAL operation, the key causes the display to reset, the present measurement to be terminated and a new measurement initiated. In remote the key causes the instrument to go into the local mode of operation with all input controls remaining in their last state. A new measurement is initiated with the display reset to "00000000" and the REM annunciator disappears.
- ⑫ A Input A Channel input. See Table 1-1 for specifications.
- ⑬ B Input B Channel input. See Table 1-1 for specifications.
- ⑭ MAN LEVEL A With the MAN LEVEL (manual level) key enabled, an arrow appears in the LCD above the label and the MANUAL LEVEL A has control to adjust the trigger level of Channel A. Channel A trigger level is variable from +0.1 to -0.1 volts (midrange is 0.0V and maximum sensitivity). Channel B is not affected by this control.

Figure 3-8. Front Panel Controls

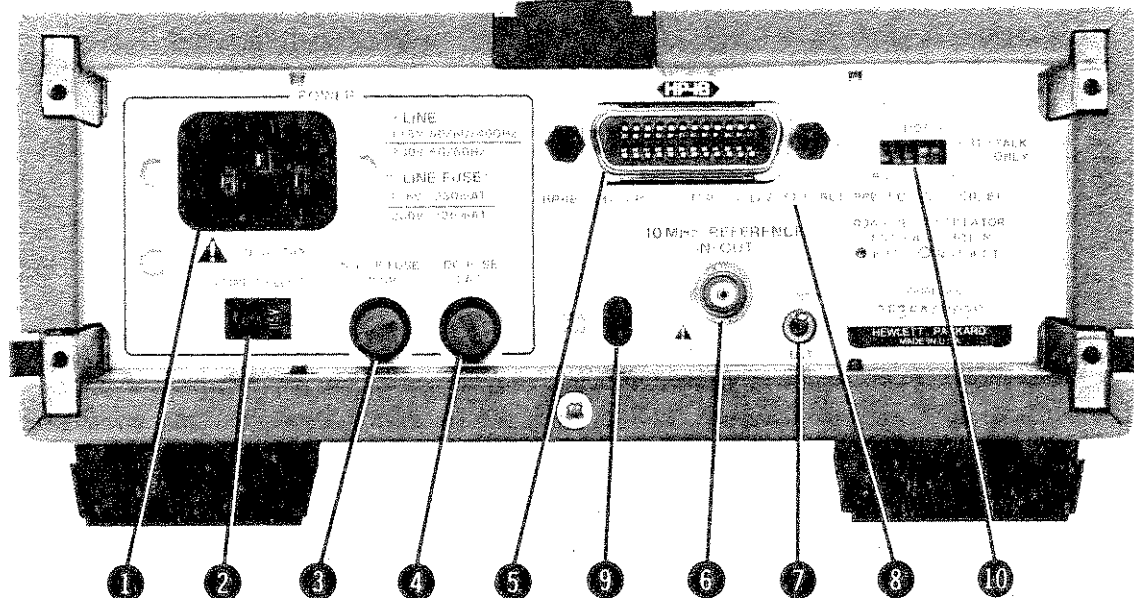

- ① AC LINE INPUT The connector accepts the ac input power cord.
- ② LINE SELECT The LINE SELECT switch selects line voltage of 115 or 230 volts. The selected voltage range is visible on the switch.
- ③ AC FUSE The AC FUSE is a .25 ampere slow blow fuse. Provides transformer overvoltage protection.
- ④ DC FUSE The DC FUSE is a 2 ampere slow blow fuse. Provides main instrument protection.
- ⑤ Interface The input/output interface connector provides remote control capabilities with HP-IB.
- ⑥ 10 MHz IN/OUT BNC Connector The 10 MHz IN/OUT BNC connector provides a 10 MHz calibration signal when the INT EXT switch is in the INT position. With the switch in the EXT position, the IN/OUT BNC connector becomes the external reference input for the counter.
- ⑦ INT EXT The switch selects the internal 10 MHz oscillator or an external reference oscillator.
- ⑧ Interface Capabilities The interface capability label lists the standard interface functions of the counter for HP-IB.
- ⑨ TCXO ADJ ONLY The internal time base oscillator is adjusted through this opening.
- ⑩ ADDR (address) The address switch is used to manually set the remote control address of the counter. The five rightmost switch positions determine the address.

Figure 3-9. Rear Panel Features



3-101. Talkers are devices that have the ability to send data or device dependent commands through the interface. Note that a talker will not actually send its data or information until told to do so by the controller. The counter has Talker capabilities. In special situations, one device may be classified as a Talk-only device and sends information to Listen-only devices. Such a system would not have a controller. For example, the counter can be configured to the Talk-only mode and send measurement results to a printer. (TALK ONLY Address = 31).

3-102. Listeners are devices with the capability to receive information over the interface. Listeners must also be enabled by the controller to receive the information.

### 3-103. INTERFACE SYSTEM TERMS

3-104. The following paragraphs define the terms and concepts used to describe HP-IB system operations.

a. ADDRESS: Each device in the interface is assigned an address. The address is used to specify which device on the interface will receive information or send information.

b. BYTE: A byte is a unit of information consisting of eight binary digits called bits.

c. DEVICE: Any instrument or unit that is HP-IB compatible is called a device.

d. DEVICE DEPENDENT: An action a device performs in response to information sent through the interface. The action is characteristic of a particular instrument and will probably vary from device to device.

e. DEVICE INDEPENDENT COMMAND: A command predefined by the interface standard to have a specified bit pattern and resulting action.

f. DEVICE DEPENDENT COMMAND: A command not predefined by the interface standard, which is specific to a particular instrument or family of instruments.

g. POLLING: Polling is a process typically used by a controller to locate a device that has requested service from the controller. There are two types of polling; Serial Poll and Parallel Poll:

1. Serial Poll. When the controller executes a serial poll, the addressed device sends one byte of operational information called a status byte. If more than one device in the interface is capable of requesting service, each device on

the interface must be serial polled until the device that requested service is located.

2. Parallel Poll. When the controller executes a parallel poll, all devices on the interface respond, each one setting or clearing a particular data bit to indicate whether or not it requested service.

### 3-105. ADDRESS SELECTION

3-106. MANUAL ADDRESSING. To use the counter in a system, set the rear panel address switches to the desired address. Addresses 0 through 30 represent the addressable mode range. Address 31 selects the Talk-only mode. The addressable mode is used when the counter functions as a talker and a listener. The TALK ONLY mode (Figure 3-10) is employed when the counter is operating in an output-only condition (no controller on the bus) and sends its data to another device on the bus, such as a printer, set to LISTEN ONLY.

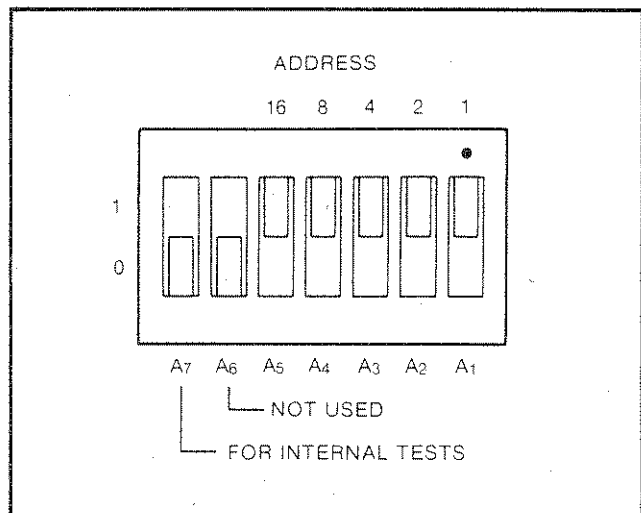

Figure 3-10. 5386A Address Switch  
Shown in Address 31

3-107. The five rightmost switches, A5 through A1, set the address of the counter. Table 3-4 shows all possible address settings and the corresponding ASCII codes used by some controllers for talk and listen. The counter is factory set to address 03 as shown in Table 3-4. Address 21 is not allowed because that address is assigned to the controller device.

3-108. The interface status of the counter is indicated on the front panel by an arrow appearing above the REM and/or ADRD labels on the front panel.





Table 3-4. Address Selection

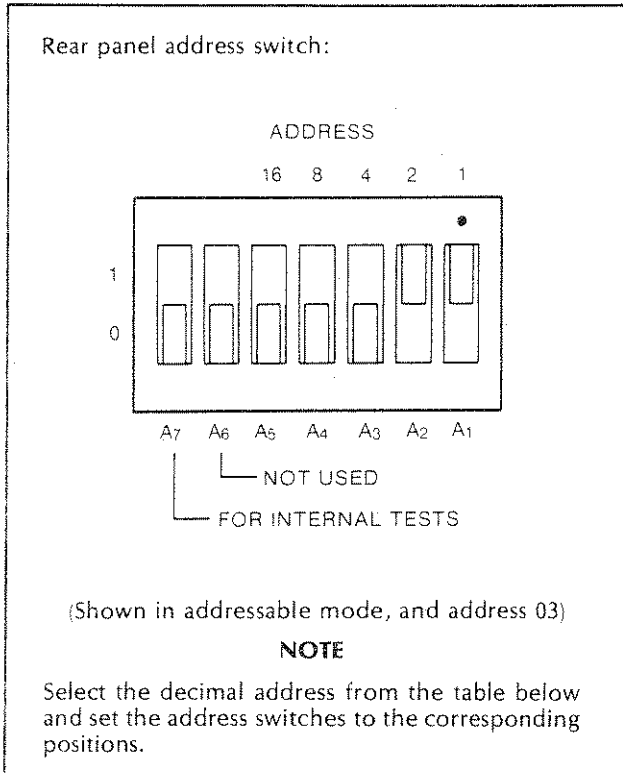

ASCII CODE CHARACTER		ADDRESS SWITCHES					5-BIT DECIMAL CODE
LISTEN	TALK	A5	A4	A3	A2	A1	
SP	@	0	0	0	0	0	00
!	A	0	0	0	0	1	01
"	B	0	0	0	1	0	02
#	C	0	0	0	1	1	03
\$	D	0	0	1	0	0	04
%	E	0	0	1	0	1	05
&	F	0	0	1	1	0	06
'	G	0	0	1	1	1	07
(	H	0	1	0	0	0	08
)	I	0	1	0	0	1	09
*	J	0	1	0	1	0	10
+	K	0	1	0	1	1	11
,	L	0	1	1	0	0	12
-	M	0	1	1	0	1	13
.	N	0	1	1	1	0	14
/	O	0	1	1	1	1	15
0	P	1	0	0	0	0	16
1	Q	1	0	0	0	1	17
2	R	1	0	0	1	0	18
3	S	1	0	0	1	1	19
4	T	1	0	1	0	0	20
5	U	1	0	1	0	1	21
6	V	1	0	1	1	0	22
7	W	1	0	1	1	1	23
8	X	1	1	0	0	0	24
9	Y	1	1	0	0	1	25
:	Z	1	1	0	1	0	26
;	[	1	1	0	1	1	27
<	\	1	1	1	0	0	28
=	]	1	1	1	0	1	29
>	~	1	1	1	1	0	30

### 3-109. INTERFACE COMMANDS

3-110. The commands that the counter recognizes can be separated into two classes: device dependent commands and device independent commands. Device dependent commands are those that are unique to the instrument and are defined by the instrument designer. They are normally sent to an instrument as ASCII strings. A detailed description of device dependent commands begins in paragraph 3-129, Device Dependent Commands.

3-111. Device independent commands, on the other hand, are defined by the interface standard document and are the same in all instruments. These commands are identified by a three letter mnemonic such as GTL, which represents Go to Local. Device independent commands are sent as specially encoded bytes on the interface and not as ASCII strings. Thus these commands cannot be sent using the OUTPUT statement on the HP-85A. However, many controllers do incorporate a command of the form SEND7;CMDnnn, where nnn is the decimal equivalent to the bit pattern corresponding to a particular device independent command.

### 3-112. INTERFACE CAPABILITIES

3-113. Since the device independent commands are standardized and are the same in all instruments, the functions these commands perform can be listed on the instrument in a standardized manner. This is known as the interface capability label.

HP-IB SH1, AH1, T5, TE0, L4, LE0, SR1, RL1, PP0, DC1, DT1, C0, E1

3-114. The number following the interface function code indicates the particular capability of that function.

3-115. Table 3-5 provides a list of the interface capabilities of the instrument.



Table 3-5. Interface Capabilities

HP-IB	DESCRIPTION
SH1	The instrument can generate messages.
AH1	The instrument can interpret received messages.
T5	The instrument can function as a talker. In addition, it can operate as a Talker Only instrument and can respond to serial poll, send device ID, and send accessory ID.
TE0	The instrument cannot function as an extended talker.
L4	The instrument can function as a listener. It will accept commands via the interface. In addition, it will untalk itself if addressed as a listener.
LE0	The instrument cannot function as an extended listener.
SR1	The instrument can generate a service request.
RL1	The instrument can operate in both remote and local modes. In addition, it can respond to local lockout.
PP0	The instrument does not support parallel poll.
DC1	The instrument supports both the device clear (DCL) and selected device clear (SDC) commands.
DT1	The instrument can be remotely triggered.
C0	The instrument cannot function as a controller.
E1	The instrument places one load on the HP-IB system.

### 3-116. META MESSAGES

3-117. In order to simplify the use of the HP-IB interface, HP has developed what is called the Meta Message concept. Rather than requiring the user to remember all the device independent messages and their interactions, useful sequences of these commands have been integrated into a single command on many of HP's controllers. For example, to clear the instrument at address 03 using the device independent commands, it is necessary to send the sequence ATN, UNL, MTA, LAD 03, SDC. In the HP-85, the command CLEAR 703 causes this sequence to be sent with no further user interaction. This greatly simplifies the use of the interface.

3-118. Many of the meta messages as implemented on the HP-85A may be sent in either of two forms, either with or without addressing. The form with addressing will normally listen address the instrument. For example, the command REMOTE 703 will

send REN and then make the instrument a listener. In the following tables, the form with addressing is shown.

3-119. Table 3-6 lists the meta messages, their results in the counter, and typical interface message sequences corresponding to them. The sequences are typical in that different controllers may send different sequences, while still obtaining the same results.

Table 3-6. Meta Messages

MESSAGE	DESCRIPTION/RESPONSE
DATA	A means to send device dependent command and receive measurement data. HP-IB: [UNL, MTA, LADn, data]
TRIGGER	Starts a new measurement.
CLEAR	Will clear the display. If in error state, clears error only. [UNL, MTA, LADn, SDC]
REMOTE	Disables front panel keys (except for Reset/Local). [REN, UNL, MTA, LADn]
LOCAL	Enables the front panel keys. [UNL, MTA, LADn, GTL]
LOCAL and CLEAR LOCKOUT	Enables the front panel keys and clears Local Lockout. HP-IB: [REN]
LOCAL LOCKOUT	Disables the Reset/Local key when in remote. [LLO]
SERVICE REQUEST	This command is ignored when received by the instrument. It will be sent by the instrument when an enabled service condition is present.
STATUS BYTE	Presents status information. [UNL, MLA, TADn, SPE, data, SPD, UNT]
STATUS BIT	Single bit parallel poll response indicates whether this instrument is requesting service. [IDY]
PASS CONTROL	Not supported.
ABORT	Terminates bus communications by unlistening and untalking all instruments. [IFC]
DEVICE ID	Causes the instrument to send the string "HP 5386A" [UNL, MLA, TADn, SDI, data]
ACCESSORY ID	Causes the instrument to send the number 81 in binary. This identifies the instrument as a measuring instrument. [UNL, MLA, TADn, SAI, data]



3-120. Table 3-7 lists the meta messages and the HP 9825 and HP-85 commands that correspond to them. (Only the addressed form is shown for the commands that support both the unaddressed and addressed forms.) The table assumes the instrument is set to address 03 and the interface to select code 7.

Table 3-7. Meta Messages and Controller Commands

MESSAGE	HP 9825	HP-85
DATA	wrt 703, A\$ red 703, A\$	OUTPUT 703; A\$ ENTER 703; A\$
TRIGGER	trg 703	TRIGGER 703
CLEAR	clr 703	CLEAR 703
REMOTE	rem 703	REMOTE 703
LOCAL	lcl 703	LOCAL 703
LOCAL/ CLEAR LOCKOUT	lcl 7	LOCAL 7
LOCKOUT	llo 7	LOCAL LOCKOUT 7
SERVICE REQUEST		STATUS 7,1; A
STATUS BYTE	rds (703)	SPOLL (703)
STATUS BIT		PPOLL (7)
PASS CONTROL		
ABORT	cli 7	ABORTIO 7
DEVICE ID		SEND 7; CMD 255
ACCESSORY ID		SEND 7; CMD 254

### 3-121. SRQ, SRQ MASK, AND STATUS BYTE

#### 3-122. SRQ and Status Byte

3-123. When in remote operation, the counter can send a service request (SRQ) to the controller to indicate the need for attention and can act as an interrupt to the current sequence of events. Typically, SRQ indicates data is ready to transmit and/or an error condition exists. The counter can send an SRQ to the controller under any, all, or none of the following conditions, as defined by the Service Request Mask.

The Service Request Mask (SM command) must be set prior to the condition. Refer to paragraph 3-127.

- a. DATA READY. A measurement has been completed and is available for collection.
- b. ERROR. An Error or Failure condition exists, and is displayed.
- c. LOCAL. The instrument is in local.

3-124. In general, the controller can read the counter Status Byte at any time to check selected operating conditions. During remote operation, you may selectively program the counter Service Request Mask (SMnnn) to identify the conditions which you feel may require service or data collection.

3-125. Once SRQ has been sent, the controller can identify which condition or conditions caused the Service Request by reading the Status Byte. When the Status Byte is read, conditions that exist will be set to 1 whether or not enabled as a condition to generate SRQ. Sending a "rds (703)" with the HP 9825A, or "A=SPOLL (703)" with the HP-85A requests the eight-bit binary status byte. The number returned will be a decimal equivalent to the sum of the different status bits set, as shown in Table 3-8.

Table 3-8. HP 5386A Status Byte

D7	D6	D5	D4	D3	D2	D1	D0
0	SRQ FLAG	POWER ON	LOCAL	0	ERROR or FAIL	0	DATA READY
128	64	32	16	8	4	2	1

3-126. For example; the instrument requested service (SRQ) and reading the Status Byte returned a value of "97". This can be interpreted as  $64 + 32 + 1 = 97$ , meaning the SRQ FLAG is set, power is on, and data is ready. The bits of the Status Byte are set regardless of the Service Request Mask. However, if that bit is masked out, it will not generate an SRQ.

#### 3-127. Service Request Mask

3-128. Upon receipt of the Service Request Mask Command (SM Command), the instrument will load the binary value of "nnn" into the service request mask register. The SRQ line bit will be "set" if a bit in the status byte becomes set and the corresponding bit in the service request mask is set. To specify the service request mask, send the SM command, followed by the decimal number that represents the sum of the bits that you want enabled. You may send any number



between "0" and "255", although only the five least significant bits are used. The binary value of "nnn" is interpreted as follows:

BIT	MEANING	(DECIMAL) WEIGHT
<b>NOT MASKABLE</b>		
Bit 7	Always 0 .....	128
Bit 6	SRQ .....	64
Bit 5	Power On .....	32
<b>MASKABLE BITS</b>		
Bit 4	Instrument in Local .....	16
Bit 3	Always 0 .....	8
Bit 2	Error or Fail Condition ...	4
Bit 1	Always 0 .....	2
Bit 0	Data Ready .....	1

For example, sending the command "SM5" will generate a service request (SRQ) after an error or fail condition or data is ready (4 + 1). Sending the command "SM0" masks off (or disables) all SRQ conditions. The condition or conditions which caused the service request may be determined by reading the Status Byte.

### 3-129. DEVICE DEPENDENT COMMANDS

3-130. The counter will accept command strings in either upper or lower case. Spaces, commas, and semicolons between commands are interpreted as command terminators. In addition, parity bits will be ignored. Depending upon the controller, this can help to speed-up programming. The following free format command statements will produce identical results:

OUTPUT 703; "FU1,AT1,FI1,ML1,GA2,DN"  
OUTPUT 703; "fu1,at1,fi1,ml1,ga2,dn"

### 3-131. Output Formats

3-132. Data is output to the HP-IB in the following format:

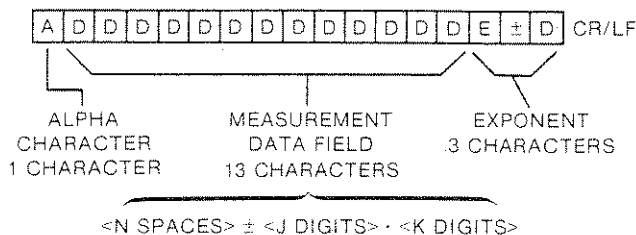

- Alpha character
- Variable number of blanks
- + or - sign
- Digit
- Decimal Point
- Variable number of digits
- E
- + or - sign
- One exponent digit
- Carriage Return
- Line Feed

3-133. Blanks are inserted to make the message 17 bytes long.

For example:  
F +4.5834126E+5<CR/LF>  
|  
17 characters

#### NOTE

There will be no decimal point in the string if it occurs just before the E (this will occur only for measurements with only one significant digit).

### 3-134. Numeric Entry

3-135. Numeric entry follows the code and format guidelines of the IEEE 728 standard for NR3 numbers. This is a "free format" type of input, with spaces allowed before a numeric entry begins, but not afterwards. A decimal point is allowed anywhere in the mantissa, but not required.

3-136. All local functions are programmable with individual command codes via the interface. In general, all functions operate the same in remote as in local. The counter commands are listed in Table 3-9, Instrument Programming Command Set.



Table 3-9. Instrument Command Set

CODE	FUNCTION	DESCRIPTION
FU1	Freq. A	Measure frequency of A-Input
FU2	Per A	Measure period of A-Input
FU3	Freq. B	Measure frequency of B-Input
CK	CHECK10MHz	Check mode (10 MHz)
AT0	Attn A (X1)	Select X1 A-Input
AT1	Attn A (X20)	Select X20 A-Input
F10	<b>FILTER A (off)</b>	<b>Disable A-Input 100 kHz LPF</b>
F11	FILTER A (on)	Enable A-Input 100 kHz LPF
ML0	<b>MAN LVL (off)</b>	<b>Disable Manual level control</b>
ML1	MAN LVL (on)	Enable Manual level control
GA1	<b>0.1s</b>	<b>Select 0.1 sec gate time</b>
GA2	1.0s	Select 1.0 sec gate time
GA3	10s	Select 10 sec gate time
RE	Reset Gate	Reset Display & restart measurement
DI	Digit Inc	Increment display digits
DD	Digit Dec	Decrement display digits
DN	<b>Digit Norm</b>	<b>Display digits normal</b>
FN11	Diag. 1	CPU self-test
FN12	Diag. 2	I/O Address
FN13	Diag. 3	Interpolator short-cal
FN14	Diag. 4	Interpolator long-cal
IN	Initialize	Reset & go to Default state
WA0	<b>Wait (off)</b>	<b>Wait-to-send data mode off</b>
WA1	Wait (on)	Wait-to-send data mode on
DR<string>	Rmte Dspy	Write to LCD "string"
DL	Lcl Dspy	Return LCD to local
ID or SI	Send ID	Send Device ID
SM<num>	SRQ mask	Set service request mask = <num>
LE	Load Error	Loads data into Error Code Register
SE	Send Error	Send error code

3-137. The examples at the end of this section demonstrate programming capabilities of the counter. The examples are written for the HP-85A controller. A summary of the program operation and a line-by-line description are provided for each example.

### 3-138. IN Initialize

3-139. This command causes the instrument to exit its current state and go to the power on initialize state unless the instrument is in an error state. If the instrument is in an error state, the error condition must be cleared before the "IN" command is accepted. The error may be cleared by pressing the blue reset key on the front panel or by sending a DCL or SDC command to the instrument.

### 3-140. WA0 and WA1 Wait to Send Mode Off/On

3-141. The wait to send mode forces the instrument to wait for a measurement to be read by the controller before it can start a new measurement. This mode is especially useful when used with service request. The instrument will make a measurement and when the measurement is complete, it will assert SRQ alerting the controller to the fact that the measurement is complete. This process ensures that the controller knows when the measurement was made and that it does not have to wait for the full duration of the measurement to receive data.

3-142. WA1 places the instrument in the wait to send mode. WA0 takes the instrument out of the wait to send mode and allows it to function in its normal state. In the normal state, measurements are made continuously regardless of whether or not those measurements were read by the controller.

### 3-143. DR (string) Remote Display

3-144. The remote display command is legal only when the counter is in the measurement mode. If the command is received while the counter is in the diagnostic mode, an error will be flagged.

3-145. The remote display command allows the user to send any message, 12 characters in length excluding punctuation, to the LCD. A punctuation mark (comma, colon, or decimal point) can be sent between each of the characters.

3-146. Although the counter will continue making measurements, the LCD will contain the message sent with the "DR" command rather than the measurement data.

3-147. Whenever a new message is to be displayed, the remote display command must be sent. Thus each new message must be sent in the form "DRXXXXXXXX", where the X's represent the message to be displayed. Carriage return, line feed, form feed, horizontal tab, and vertical tab can be used as terminators for a



remote display message. A message sent to the display will remain there until a command which causes a change in the display is sent to the counter.

3-148. The remote display mode can be terminated in several ways. Sending a "DL" (display local) command will terminate the remote display mode without changing the state of the counter in any other way. When the counter receives this command, it will clear the display and resume displaying measurement data. Sending a diagnostic command also terminates the remote display mode, but it causes the counter to exit the measurement mode as well. Pressing the RESET/LOCAL key is another way of terminating the remote display mode, however, the key will cause the counter to exit the remote state and enter the local state. Any transition from the remote state to the local state, caused by the controller, will terminate the remote display mode as well.

3-149. If an error condition is generated while the instrument is in the remote display mode, the error message will be displayed just as in any other case. However, when the error is cleared, the counter will no longer be in the remote display mode; it will begin displaying the measurement data rather than the message contained in the LCD prior to the error condition.

### 3-150. DL Display Local

3-151. The display local command allows the user to terminate the remote display mode without changing the state of the counter in any other way. When the counter receives this command, it will clear the remote display message and begin displaying measurement data.

### 3-152. ID and SI Send Device ID

3-153. These two commands perform the same function. Whenever the counter receives either of

these two commands, it will send its ID to the controller. "HP 5386A" will be sent to the controller. The counter will wait until the device ID is read by the controller before it will resume taking measurements again.

### NOTE

The counter will not return a device ID when set to Channel B and no signal is applied to Channel B.

### 3-154. SE Send Error

3-155. When the send error command is received, the instrument will send the number of the detected error (there may be more than one) to the interface bus. We recommend the "SE" command be used in a string by itself.

### 3-156. LCD Character Set

3-157. *Table 3-10* shows the characters the instrument can produce. Included in the table is the code needed to produce the character and how the displayed character will look.

## 3-158. PROGRAM EXAMPLES

3-159. The following examples demonstrate programming capabilities of the HP 5386A. The four examples are written for the HP-85A controller. A summary of the program operation and a line-by-line description are provided for each example.

- Example 1 Instrument Identification
- Example 2 Reading Status Byte
- Example 3 Frequency A
- Example 4 Remote Display



## EXAMPLE 1. INSTRUMENT IDENTIFICATION

The following example demonstrates how to display the identification address of the counter on the display screen of the controller. The program clears the HP 5386A then requests the instrument identification. The response is read into "N\$", which is then displayed.

### PROGRAM

```
10 REM Example #1: INSTRUMENT IDENTIFICATION
20 CLEAR @ DISP USING "5/"
30 DISP "Searching for 5386A address . . ." @ DISP
40 N$="NOT 5386A"
50 FOR S=700 TO 730
60 IF S=721 THEN 140
70 DISP S @ BEEP 250,75
80 SET TIMEOUT 7;100
90 OUTPUT S ; "ID"
100 ENTER S ; N$
110 IF N$="HP5386A" THEN 230
120 CLEAR S
130 ABORTIO 7
140 NEXT S
150 BEEP 200,200
160 CLEAR @ DISP USING "5/"
170 DISP "Address not found." @ DISP
180 DISP "Verify HP-IB connection and that the 5386A is not in the TALK"
190 DISP "ONLY mode."
200 DISP @ DISP "Press 'CONT' when ready."
210 PAUSE
220 GOTO 20
230 DISP @ BEEP @ DISP "HP 5386A FOUND AT ADDRESS";S;"!"
240 END
```

### PROGRAM DESCRIPTION

- Line 10 Remarks; comments only, does not affect the program.
- Line 20 Clears the controller display only and places the cursor near the middle of the controller display screen.
- Line 30 Message inside quotes is displayed on controller display screen and the cursor skips one line.
- Line 40 Set "N\$" equal to "not 5386A".
- Line 50 Loop "S" from address 700 to 730
- Line 60 If instrument value = 721 (calculator address) then go to line 140.
- Line 70 Display instrument address and beep. The number "75" determines the length of time of the beep and "250" determines the pitch.
- Line 80 Set time out on address 7 to 100 ms.
- Line 90 Send "ID" command to instrument with address = to "S".
- Line 100 Read instrument "ID" response into "N\$".
- Line 110 If contents of "N\$" equals "5386A", then jump to line 230.
- Line 120 Clear instrument at address "S".
- Line 130 Terminates any data transfer on address 7.
- Line 140 Increment to next address.
- Line 150 Beep.
- Line 160 Clears controller display only and places the cursor near the middle of the controller display.
- Line 170 Display string within quotes on the controller display and skip on line.
- Line 180 Display string within quotes on controller screen.
- Line 190 Display string within quotes on controller screen.
- Line 200 Skip one line and display string within quotes on controller display.
- Line 210 Halt program until user presses "CONT".
- Line 220 Go to line 20.
- Line 230 Skip a line, beep and display string within quotes and the address of HP 5386A.
- Line 240 End program execution.



## EXAMPLE 2. READING STATUS BYTE

The following example reads the status byte of the HP 5386A by a serial poll at address 03. The value returned is input into "A". The program first displays the status byte prior to the error condition. After the error condition is generated by sending an illegal command "FU5", the program again displays the status byte of a different value.

### PROGRAM

```

10 REM Example #2: READING STATUS BYTE
20 S=703
30 CLEAR @ DISP USING "3/"
40 OUTPUT S ; "SM5"
50 A=SPOLL(S)
60 DISP "The value of the status byte prior to the error condition is"
70 DISP "equal to";A;"."
80 DISP
90 DISP "press 'CONT' to generate an SRQ and alter the status byte value."
100 DISP @ PAUSE
110 BEEP
120 OUTPUT S ; "FU5"
130 A=SPOLL(S)
140 DISP "The value of the status byte after the error condition is"
150 DISP "equal to";A;"."
160 END

```

### PROGRAM DESCRIPTION

Line 10 Remarks; comments only, does not affect the program.

Line 20 Set "S" = to 703.

Line 30 Clears the controller display only and the cursor skips three lines. The reason for skipping 3 lines is simply to bring the cursor near the middle of the display screen.

Line 40 Send service request mask to HP 5386A at address equal to "S" for error or failure condition or data ready condition.

Line 50 Read status of HP 5386A (into A) by a serial poll at address equal to "S".

Line 60 Display message within quotes.

Line 70 Display message within quotes and the status byte.

Line 80 Skip one line on controller screen.

Line 90 Display message within quotes.

Line 100 Skip one line on controller screen and halt program execution until user presses "CONT".

Line 110 Beep.

Line 120 Output "FU5" command to HP 5386A at address "S" ("FU5" will generate an error condition).

Line 130 Read the status of HP 5386A (into A) by a serial poll at address "S".

Line 140 Display message within quotes.

Line 150 Display message within quotes and status byte.

Line 160 End program execution.





### EXAMPLE 3. FREQUENCY A

The following example demonstrates how to display a Frequency A measurement on the controller display screen. The address is set to 03 and the "IN" command is sent to the HP 5386A. The response is read into "A\$", which is then displayed.

#### PROGRAM

```
10 REM Example #3: FREQUENCY A
20 S=703
30 OUTPUT S ;"IN"
40 ENTER S ; A$
50 DISP "FREQUENCY A ="; A$[2]
60 GOTO 30
70 END
```

#### PROGRAM DESCRIPTION

Line 10 Remarks; comments only, does not affect the program.  
Line 20 Set "S" equal to 703.  
Line 30 Output "IN" command to HP 5386A at address "S".  
Line 40 Read HP 5386A response into "A\$".  
Line 50 Display "Frequency A="; followed by the contents of the second character onward of "A\$".  
Line 60 Go to line 30.  
Line 70 End program execution.

### EXAMPLE 4. REMOTE DISPLAY

The following example demonstrates how to send messages to the display of the counter. The program sets the address to 03 then sends a message to the display of the counter.

#### PROGRAM

```
10 REM Example #4: REMOTE DISPLAY
20 S=703
30 OUTPUT S ;"DR HP 5386A"
40 END
```

#### PROGRAM DESCRIPTION

Line 10 Remarks; comments only, does not affect the program.  
Line 20 Set "S" equal to 703.  
Line 30 Send remote display message (HP 5386A) to instrument at address "S".  
Line 40 End program execution.



Table 3-10. LCD Character Set

LCD CHAR.	ASCII CHAR.	DECIMAL	LCD CHAR.	ASCII CHAR.	DECIMAL	LCD CHAR.	ASCII CHAR.	DECIMAL
	NULL, @	0, 64		SYNC, V	22, 86		,	44
	SOH, A	1, 65		ETB, W	23, 87		—, m	45, 109
	STX, B	2, 66		CAN, X	24, 88		.	46,
	EXT, C	3, 67		EM, Y	25, 89		/, o	47, 111
	EOT, D	4, 68		SUB, Z	26, 90		0, p	48, 112
	ENQ, E	5, 69		ESC,	27, 91		1, q	49, 113
	ACK, F	6, 70		FS, \	28, 92		2, r	50, 114
	BELL, G	7, 71		GS,	29, 93		3, s	51, 115
	BS, H	8, 72		RS, ^	30, 94		4, t	52, 116
	HT, I	9, 73		US, _	31, 95		5, u	53, 117
	LF, J	10, 74		space, `	32, 96		6, v	54, 118
	VT, K	11, 75		!, a	33, 97		7, w	55, 119
	FF, L	12, 76		", b	34, 98		8, x	56, 120
	CR, M	13, 77		#, c	35, 99		9, y	57, 121
	SO, N	14, 78		\$, d	36, 100		z	122
	SI, O	15, 79		%, e	37, 101		:	58, 122
	DLE, P	16, 80		&, f	38, 102		;	59, 123
	DC1, Q	17, 81		', g	39, 103		<,	60, 124
	DC2, R	18, 82		(, h	40, 104		=, }	61, 125
	DC3, S	19, 83		), i	41, 105		>, ~	62, 126
	DC4, T	20, 84		*, j	42, 106		?, DEL	63, 127
	NAK, U	21, 85		+, k	43, 107		l	108
							n	110